

CWMA Laws and Regulations (L&R) Committee 2023 Interim Meeting Report

Mr. Mike Harrington, Committee Chair
Iowa

INTRODUCTION

The L&R Committee (hereinafter referred to as the “Committee”) submits this Committee Interim Report for consideration by National Conference on Weights and Measures (NCWM). This report contains the items discussed and actions proposed by the Committee during the January Interim Meeting. The report will address the items in Table A during the Interim Meeting. Table A identifies the agenda items by reference key, title of item, page number and the appendices by appendix designations. The acronyms for organizations and technical terms used throughout the agenda are identified in Table B. The headings and subjects apply to NIST Handbook 130, “Uniform Laws and Regulations in the Areas of Legal Metrology an Engine Fuel Quality,” and NIST Handbook 133, “Checking the Net Contents of Packaged Goods.” The first three letters of an item’s reference key are assigned from the Subject Series List. The status of each item contained in the report is designated as one of the following: **(D) Developing Item:** the Committee determined the item has merit; however, the item was returned to the submitter or other designated party for further development before any action can be taken at the national level; **(A) Assigned Item:** the committee has assigned development of the item to a recognized subcommittee or task group within NCWM. **(I) Informational Item:** the item is under consideration by the Committee but not proposed for Voting; **(V) Voting Item:** the committee is making recommendations requiring a vote by the active members of NCWM; **(W) Withdrawn Item:** the item has been removed from consideration by the Committee.

Some Voting Items are considered individually; others may be grouped in a consent calendar. Consent calendar items are Voting Items that the Committee has assembled as a single Voting Item during their deliberation after the Open Hearings on the assumption that the items are without opposition and will not require discussion. The Voting Items that have been grouped into consent calendar items will be listed on the addendum sheets. Prior to adoption of the consent calendar, the Committee will remove specific items from the consent calendar upon request to be discussed and voted upon individually.

Committees may change the status designation of agenda items (Developing, Informational, Assigned, Voting and Withdrawn) up until the report is adopted, except those items which are marked Developing, Informational, Assigned or Withdrawn cannot be changed to Voting Status. Any change from the Committee Interim Report (as contained in this publication) or from what appears on the addendum sheets will be explained to the attendees prior to a motion and will be acted upon by the active members of NCWM prior to calling for the vote.

An “Item under Consideration” is a statement of proposal and not necessarily a recommendation of the Committee. Suggested revisions are shown in **bold face print** by ~~striking out~~ information to be deleted and **underlining** information to be added. Requirements that are proposed to be nonretroactive are printed in **bold faced italics**. Additional letters, presentation and data may have been submitted for consideration with this item. Please refer to <https://www.ncwm.com/publication-16> to review these documents.

All sessions are open to registered attendees of the conference. If the Committee must discuss any issue that involves proprietary information or other confidential material; that portion of the session dealing with the special issue may be closed if (1) the Chairman or, in his absence, the Chairman-Elect approves; (2) the Executive Director is notified; and (3) an announcement of the closed meeting is posted on or near the door to the meeting session and at the registration desk. If possible, the posting will be done at least a day prior to the planned closed session.

Note: It is policy to use metric units of measurement in publications; however, recommendations received by NCWM technical committees and regional weights and measures associations have been printed in this publication as submitted. Therefore, the report may contain references to inch-pound units.

Subject Series List

Handbook 130 – General.....	GEN Series
Uniform Laws	
Uniform Weights and Measures Law.....	WAM Series
Uniform Weighmaster Law.....	WML Series
Uniform Fuels and Automotive Lubricants Inspection Law.....	FLL Series
Uniform Regulations	
Uniform Packaging and Labeling Regulation.....	PAL Series
Uniform Regulation for the Method of Sale of Commodities.....	MOS Series
Uniform Unit Pricing Regulation.....	UPR Series
Uniform Regulation for the Voluntary Registration of Servicepersons and Service Agencies for Commercial Weighing and Measuring Devices.....	RSA Series
Uniform Open Dating Regulation.....	ODR Series
Uniform Regulation for National Type Evaluation.....	NTP Series
Uniform Fuels and Automotive Lubricants Regulation.....	FLR Series
Examination Procedure for Price Verification.....	PPV Series
NCWM Policy, Interpretations, and Guidelines.....	POL Series
Handbook 133.....	NET Series
Other Items.....	OTH Series

**Table A
Table of Contents**

Reference Key	Title of Item	L&R Page
PAL – UNIFORM PACKAGING AND LABELING REGULATION		97
PAL-24.1	10.11. <i>Cannabis</i> and <i>Cannabis</i> -Containing Products	97
MOS – UNIFORM REGULATION FOR THE METHOD OF SALE OF COMMODITIES		101
MOS-24.2	2.16.3.1. Tare Weights, Part (c) Allowable difference.	101
MOS-24.3	2.16.3.1. Tare Weights, Part (d) Average requirement	104
MOS-24.4	2.16.3.1. Tare Weights, Part (e) Tare Determination.....	106
MOS-24.5	2.27. Pet Treats or Chews.	108
RSA – UNIFORM REGULATION FOR THE VOLUNTARY REGISTRATION OF SERVICE PERSONS AND SERVICE AGENCIES FOR COMMERCIAL WEIGHING AND MEASURING DEVICES.....		110
RSA-24.1	Section 4. Voluntary Registration.....	110
FLR – UNIFORM FUELS AND AUTOMOTIVE LUBRICANTS REGULATION		113
FLR-23.3	D Section 2.20. Hydrogen Fuel.	113
PPV – EXAMINATION PROCEDURE FOR PRICE VERIFICATION		116
PPV-24.1	Table 1. Samples, Sample Collection, and Accuracy Requirements	116
NET – HANDBOOK 133: CHECKING THE NET CONTENT OF PACKAGED GOODS		119
NET-22.1	A HB133, Section 1.2.6. Deviations Caused by Moisture Loss or Gain and Section 2.3.8. Table 2-3 Moisture Allowances.....	119
NET-24.1	Section 3.11. Ice Cream Novelties.....	125
NET-24.2	Section 4.9. Procedure for Checking the Contents of Specific Agriculture Seed Packages Labeled by Count., and Appendix D. AOSA Rules for Testing Seeds.....	136
OTH – OTHER ITEMS		144
OTH-24.1	X. Uniform Shipping Law	144
OTH-07.1	D Fuels and Lubricants Subcommittee.....	150
OTH-11.1	D Packaging and Labeling Subcommittee.....	152
ITEM BLOCK 1 (B1) RENEWABLE DIESEL AND DIESEL.....		154
B1: MOS-23.1	A Sections 2.31. Biodiesel and biodiesel Blends that Contain Greater Than or Equal to 21% by Volume Biodiesel. and 2.40. Diesel Fuel.	154
B1: FLR-23.1	A Sections 1.9. Biodiesel Blend., 1.27. Fuel Oil., 1.XX. Renewable Diesel., 3.3.2. Automotive Fuel Rating., 3.15. Biodiesel and Biodiesel Blends Containing Greater than 20% by Volume Biodiesel.,	156
ITEM BLOCK 2 (B2) REFERENCE ASTM STANDARDS D8080 AND D8487.....		171
B2: MOS-24.1	2.9. Liquefied Natural Gas (LNG) Vehicle Fuel., 2.10. Compressed Natural Gas (CNG)., and 2.XX. Compressed Natural Gas (CNG) Blended with Hydrogen.....	171
B2: FLR-24.1	3.11.2.1.X. Identification of Grade. and 3.12.2.X. Identification of Grade.	172

Table B
Glossary of Acronyms and Terms

Acronym	Term	Acronym	Term
ASTM	ASTM International	NEWMA	Northeastern Weights and Measures Association
API	American Petroleum Institute	NIST	National Institute of Standards and Technology
CFR	Code of Federal Regulations	NCWM	National Conference on Weights and Measures
CWMA	Central Weights and Measures Association	OWM	Office of Weights and Measures
FALS	Fuels and Lubricants Subcommittee	PALS	Packaging and Labeling Subcommittee
FDA	Food and Drug Administration	S&T	Specifications and Tolerances
FTC	Federal Trade Commission	SAE	SAE International
HB	Handbook	SWMA	Southern Weights and Measures Association
ILMA	Independent Lubricant Manufacturers Association	UPLR	Uniform Packaging and Labeling Regulation
L&R	Laws and Regulations	USDA – FSIS	U.S. Department of Agriculture – Food Safety and Inspection Service
LPG	Liquefied Petroleum Gas	USNWG	U.S. National Work Group
MAV	Maximum Allowable Variation	WWMA	Western Weights and Measures Association

Details of All Items
(In order by Reference Key)

1 **PAL – UNIFORM PACKAGING AND LABELING REGULATION**

2 **PAL-24.1 10.11. Cannabis and Cannabis-Containing Products.**

3
4 **Source:**
5 Doctors for Cannabis Regulation

6 **Purpose:**
7 Provide states with a universal symbol to clearly identify products containing intoxicating cannabinoids. At present,
8 there are several symbols being used which is an issue right now with multistate *Cannabis* license holders who are
9 required to have different packaging in each jurisdiction. NCWM providing a symbol that states can adopt as they see
10 fit can begin to harmonize under one symbol, which will avoid major headaches in the event of federal legalization.

11 **Item under Consideration:**
12 Amend Handbook 130 Uniform Packaging and Labeling Regulation as follows:

13 **10.11. Cannabis and Cannabis-Containing Products** (See Section 10.11. NOTE)

14
15 **10.11.1. Definition.** – *Cannabis* is a genus of flowering plants in the family Cannabaceae, of which
16 *Cannabis sativa, indica, ruderalis* are species., and any hybridization thereof. This definition includes
17 products that contain 0.3 percent or less of Total Delta-9 Tetrahydrocannabinol (THC) (also known as
18 Hemp) and products that contain more than 0.3 percent of Total Delta-9 THC (also known as *cannabis*,
19 marijuana, or marihuana).

20
21 **10.11.2. Labeling.** – Any *Cannabis* or *Cannabis*-containing products intended for human or animal
22 consumption or application, shall bear on the outside of the package the following:

- 23
24 (a) On the principal display panel
- 25 1. The statement “Contains *Cannabis*.” The word “*Cannabis*” shall be capitalized and italicized;
 - 26 2. The statement “Contains 0.3 % or less Total Delta-9 THC” or “Contains more than 0.3 % Total
27 Delta-9 THC”; and

28
29 **3. Shall display a Cannabis Leaf symbol in accordance with the latest version of ASTM**
30 **D8441/D8441M Standard Specification for an International Symbol for Identifying Consumer**
31 **Products Containing Intoxicating Cannabinoids.**















32 **Previous Status:**
33 2024: New Proposal

34 **Original Justification:**
35 Uniform product identity is crucial to continue establishing consumer trust and equity in each transaction. We believe
36 it’s important that consumers understand whether a product they are buying contains intoxicating cannabinoids.

1 There are currently 14 different symbols being used in the US, none of which comply with ISO/ANSI standards for
2 warning symbols (table below). The US needs a pathway to uniform intoxicating product identification to solve
3 multistate operator cost of compliance and provide a pathway for a future of interstate commerce.

4
5 ASTM International Technical Committee D37 on Cannabis has developed *D8441/D8441M Standard Specification*
6 *for an International Symbol for Identifying Consumer Products Containing Intoxicating Cannabinoids* (IICPS),
7 which defines specifications for a harmonized graphical symbol that can be used as a means of identifying consumer
8 products containing intoxicating cannabinoids. The symbol is available without having to pay for the ASTM
9 standard by visiting <https://www.dfcf.org/universal-cannabis-symbol> or the websites of state agencies who have
10 already adopted it, which are Montana, Vermont, South Dakota, and New Jersey.

11
12 Multi-state operators currently have different symbol requirements, with compliance cost and hassle involved in
13 having to use different symbols in different states. Providing the industry with the option of adopting a symbol based
14 on a consensus standard positions NCWM to become the natural answer to a future of interstate commerce, likely
15 after future federal legalization, making the NIST Handbook 130 the ideal home for reference to a universal symbol
16 that provides states the option to adopt at their own discretion at any pace they like, before or after any federal
17 legalization.

Symbol design	Authorities having jurisdiction (AHJs) using the symbol	Shape of outline (conventional meaning)	Emphasized color (conventional meaning)	Number of colors (including white)	Graphical element (cannabis leaf)	Large graphical element for the visually impaired	Text excluded from interior of symbol	ISO & ANSI compliant
	IIICPS: MT, NJ, SD, & VT	Triangle (warning)	Yellow (caution)	2	Yes	Yes	Yes	Yes
	AR	None	None	2	No	No	No	No
	AZ, CO, FL, & OH	Diamond (none)	Red (prohibition)	2	No	No	No	No
	CA	Triangle (warning)	None	2	Yes	No	No	No
	CT, MA, ME, & RI	Triangle (warning)	Red (prohibition)	3	Yes	Yes	Yes	No
	MD	Triangle (warning)	Red (prohibition)	2	Yes	No	No	No
	MI	Inverted triangle (none)	Green (safe condition)	2	Yes	Yes	No	No
	NM	Diamond (none)	Red (prohibition)	2	No	No	No	No
	NV	Triangle (warning)	None	2	No	No	No	No
	NY	Square (none)	Yellow, red (caution, prohibition)	4	Yes	No	No	No
	OK	Rectangle (none)	Red (prohibition)	3	Yes	No	No	No
	OR	Rectangle (none)	Red (prohibition)	3	Yes	Yes	No	No
	WA	Diamond (none)	Yellow, green (caution, safe condition)	4	Yes	Yes	No	No
	Canada	Octagon (stop)	Red (prohibition)	3	Yes	Yes	No	No

1

2 The submitter pointed out the following possible arguments and responses.

3 **NCWM doesn't measure intoxicating cannabinoids, so we shouldn't have to label it.** We think this is not
 4 unlike the recently passed regulations requiring "*Cannabis*" to appear on the PDP. Here, we're going further
 5 with product identification.

6
 7 **The CTG just passed product identification standards. Why this now?** The *Cannabis* industry is dynamic
 8 and travels faster than the recently approved standards that were originally submitted years ago

1
2 **This will conflict with the symbol selected by my state.** States have discretion on adoption. Passing this
3 standard allows for maximum flexibility for states to adopt it when they are ready.

4 The submitter requested Voting status in 2024.

5 **Comments in Favor:**

6 **Regulatory:**

- 7 •

8 **Industry:**

- 9 •

10 **Advisory:**

- 11 •

12 **Comments Against:**

13 **Regulatory:**

- 14 •

15 **Industry:**

- 16 •

17 **Advisory:**

- 18 •

19 **Neutral Comments:**

20 **Regulatory:**

- 21 •

22 **Industry:**

- 23 •

24 **Advisory:**

- 25 •

26 **Item Development:**

27 New Proposal

28 **Regional Associations' Comments:**

29 New Proposal

30 Additional letters, presentation and data may have been submitted for consideration with this item. Please refer to
31 <https://www.ncwm.com/publication-15> to review these documents.

PAL-24.1	
Regional recommendation to NCWM on item status:	
<input checked="" type="checkbox"/> Recommend as a Voting Item on the NCWM agenda <input type="checkbox"/> Recommend as an Information Item on the NCWM agenda <input type="checkbox"/> Recommend as an Assigned Item on the NCWM agenda <i>(To be developed by an NCWM Task Group or Subcommittee)</i> <input type="checkbox"/> Recommend as a Developing Item on the NCWM agenda <i>(To be developed by source of the proposal)</i> <input type="checkbox"/> Recommend Withdrawal of the Item from the NCWM agenda <i>(In the case of new proposals, do not forward this item to NCWM)</i> <input type="checkbox"/> No recommendation from the region to NCWM <i>(If this is a new proposal, it will not be forwarded to the national committee by this region)</i>	
Comments and justification for the regional recommendation to NCWM: <i>(This will appear in NCWM reports)</i>	
<p>Mike Harrington, Iowa commented that this item does not pertain specifically to his state, but he believes it will be federally legalized so supports the standards moving forward. He further commented that states who do not have legal use of cannabis should still be involved in helping develop the standard once it is legalized federally. Chris Guay, CGGT, concurs. He believes having consistency across states is important to establish a benchmark developed by NCWM. Steve Peter, representing himself, concurs and supports the item moving forward.</p> <p>The committee agrees this item is developed and ready for voting status.</p>	

1 **MOS – UNIFORM REGULATION FOR THE METHOD OF SALE OF COMMODITIES**

2 **MOS-24.2 2.16.3.1. Tare Weights, Part (c) Allowable difference.**

3 **Source:**

4 National Propane Gas Association

5 **Purpose:**

6 Resolve the discrepancy that exists between Handbook 130 and Title 49 of the Code of Federal Regulations with
 7 respect to the allowable differences between the stamped tare weight and the actual tare weight of cylinders used for
 8 compressed or liquefied gases in refillable cylinders.

9 **Item under Consideration:**

10 Amend the Uniform Regulation for the Method of Sale of Commodities as follows:

11 **2.16.3.1. Tare weights.**

12 ...

13 **(e) Allowable difference.** – If the stamped or stenciled tare is used to determine the net contents of the cylinder,
 14 the allowable difference between the actual tare weight and the stamped (or stenciled) tare weight, or the tare
 15 weight on a tag attached to the cylinder for a new or used cylinder, shall be within **the following limits**
 16 **prescribed by 49 CFR § 178.35:**

17 (1) ~~$\frac{1}{2}$ % for tare weights of 9 kg (20 lb) or less~~ **For a cylinder of 25 pounds or less at the time of**
 18 **manufacture, a lower tolerance of 3 percent and an upper tolerance of 1 percent;** or

19 (2) ~~$\frac{1}{4}$ % for tare weights of more than 9 kg (20 lb)~~ **For a cylinder exceeding 25 pounds at the time**
 20 **of manufacture, a lower tolerance of 2 percent and an upper tolerance of 1 percent.**

1 **NOTE:** Failure of a cylinder tare weight to be within the required allowable difference is considered a
2 Method of Sale violation. The cylinder shall be removed from use until the tare weight is corrected.

3 **Previous Status:**

4 2024: New Proposal

5 **Original Justification:**

6 The data presented in NIST Special Publication, “NIST SP 2200-01, 2022 NCWM-NIST National Survey on 20
7 lb LPG (Propane) Cylinders,” is sufficient evidence that the tolerances imposed in Handbook 130 on the marking
8 of tare weights for propane cylinders are not in sync with the real world. For example, the report states that “*nearly*
9 *half (44.3%) of new cylinders and significantly less (32.0% of used cylinders were in compliance with existing*
10 *tare weight requirements,*” (in reference to the current Handbook 130 requirements). Which means, of course
11 that the great majority of cylinders, even new cylinders, were not in compliance. The reasons for that include the
12 following:

- 13 • As quoted from the report, “*Initial assessments suggest that cylinder manufactures use a tolerance of*
14 *1%, which is primarily based on Measurement Canada’s requirement of 1%.*” If a cylinder’s tare weight
15 can vary +/- 1% from stamped value as manufactured, a cylinder’s actual tare weight cannot be expected
16 to be within +/- 0.5% of the marked value after the cylinder at any point in time thereafter.
- 17 • For practical reasons, some manufacturers may use a statistical method to arrive at an average tare weight
18 based on previous measurements of a sufficiently large sample pool. Whatever variance there may be in
19 the actual weight of the cylinder versus the marked tare weight, the fact is that over 98% of the new
20 cylinders weighed were in compliance with the DOT tolerances.
- 21 • The following statement from the report is very telling: “*It is highly unusual and irregular to see a*
22 *tolerance where a very significant majority of the packages are in compliance (in this case, 98.4%).*”
23 The report goes on to state that 34.3% of “used” cylinders would not be in compliance with the DOT
24 tolerances. These two statements call attention to the fact that these grill cylinders are in constant
25 circulation, subject to a wide variety of conditions, treatment and possible abuse by potentially many
26 different customers, thereby underlining the need to steer clear of overburdensome and unwarranted
27 regulation.
- 28 • Scales utilized in most retail locations where cylinders are filled are beam scales which do not have the
29 capability of weighing cylinders to the sensitivity or number of decimal places necessary to verify the
30 initial tare weight while a cylinder is under vacuum using Handbook 130 requirements. Additionally,
31 there is no requirement in any national code or standard to fill cylinders by weight at the point of sale
32 when the cylinder is transported for non-commercial use. These cylinders are not considered to be
33 transported “in commerce” and are therefore not required to be filled by weight, thereby allowing for the
34 determination of maximum fill level using the fixed maximum liquid level gauge. Scales are not required
35 to be installed at these facilities.
- 36 • Even when the product is released to the atmosphere to “empty” the cylinder, there will always be some
37 amount of liquid and vapor remaining in the cylinder, unless the cylinder has been put under vacuum.
38 The liquid, of course, is much denser than air and the vapor in the cylinder is 1.5 times the weight of the
39 air that was in the sample cylinders when they were weighed to establish the “average” tare weights.
- 40 • A minus tolerance of -3% will not result in extreme loss to the propane marketer in most cases, because
41 the overfilling prevention device (OPD) will activate and prevent the overfilling of the cylinder in the
42 vast majority of cases. As stated in the report, only 1.1% of all cylinders tested exceeded the legal filling
43 limit. Considering the time of year that this project was undertaken and in some northern states, it is very
44 likely that some of those cylinders may have been filled volumetrically when the temperature was below
45 40 °F, it would not be unusual that more product was put into the cylinder because the OPD is calibrated
46 to the maximum fill at 40 °F and the liquid density increases as the temperature gets colder.
- 47 • The price for a pound of propane as stated in the report seems high, as it would equate to \$5.51 per gallon
48 (4.24 lbs. per gallon). The Department of Energy published the average cost of propane in 2022 and it
49 was shown to be \$2.23 per gallon.

50 Opposing arguments may take the following form:

- 1 • “The purpose of Handbook 130 is to ensure that the customer gets what he pays for and that the propane
2 marketer doesn’t lose out, either.” The rebuttal to this argument from the standpoint of the customer is
3 provided in the justification in number 18 above. From the marketer’s standpoint, the fact that the vast
4 majority of retail gallons sold in the U.S. are sold by NPGA members and that those very members
5 endorsed this proposal is evidence that marketers are not concerned about the small quantities of gas that
6 may not be billed to the customer.
- 7 • “We should make DOT change their tolerances instead of NCWM changing theirs.” The fact is that
8 NCWM allowable differences are so unreasonable that 56% of newly manufactured cylinders were not
9 in compliance with them. That should be reason enough to realize that NCWM needs to change. In
10 addition, once gas is put into a cylinder, there will always be a little bit of liquid remaining in the cylinder
11 unless it is vacuum purged or opened to the atmosphere. This means that accurately measuring the tare
12 weight of a cylinder becomes very difficult unless specific procedures are followed to ensure that the
13 cylinder is truly “empty.”

14 The submitter requested that this be a voting item in 2024 and a retroactive requirement, enforceable to all devices.

15 **Comments in Favor:**

16 **Regulatory:**
17 •

18 **Industry:**
19 •

20 **Advisory:**
21 •

22 **Comments Against:**

23 **Regulatory:**
24 •

25 **Industry:**
26 •

27 **Advisory:**
28 •

29 **Neutral Comments:**

30 **Regulatory:**
31 •

32 **Industry:**
33 •

34 **Advisory:**
35 •

36 **Item Development:**

37 New Proposal

38 **Regional Associations’ Comments:**

39 New Proposal

1 Additional letters, presentation and data may have been submitted for consideration with this item. Please refer to
2 <https://www.ncwm.com/publication-15> to review these documents.

MOS-24.2
Regional recommendation to NCWM on item status: <input type="checkbox"/> Recommend as a Voting Item on the NCWM agenda <input checked="" type="checkbox"/> Recommend as an Information Item on the NCWM agenda <input type="checkbox"/> Recommend as an Assigned Item on the NCWM agenda <i>(To be developed by an NCWM Task Group or Subcommittee)</i> <input type="checkbox"/> Recommend as a Developing Item on the NCWM agenda <i>(To be developed by source of the proposal)</i> <input type="checkbox"/> Recommend Withdrawal of the Item from the NCWM agenda <i>(In the case of new proposals, do not forward this item to NCWM)</i> <input type="checkbox"/> No recommendation from the region to NCWM <i>(If this is a new proposal, it will not be forwarded to the national committee by this region)</i>
Comments and justification for the regional recommendation to NCWM: <i>(This will appear in NCWM reports)</i> No comments were heard. Because of no comments, the committee recommends this item be informational.

3

4 **MOS-24.3** **2.16.3.1. Tare Weights, Part (d) Average requirement.**

5 **Source:**
6 National Propane Gas Association

7 **Purpose:**
8 Remove an ambiguous and subjective requirement that is based on a statistical approach not clearly defined.

9 **Item under Consideration:**
10 Amend the Uniform Regulation for the Method of Sale of Commodities as follows:

11 **2.16.3.1. Tare weights.**

12 ...

13 ~~(d) Average requirement. When used to determine the net contents of cylinders, the stamped or stenciled~~
14 ~~tare weights of cylinders at a single place of business found to be in error predominantly in a direction~~
15 ~~favorable to the seller and near the allowable difference limit shall be considered to be not in~~
16 ~~conformance with these requirements.~~

17 **Previous Status:**
18 2024: New Proposal

1 **Original Justification:**

2 Deleting (d) is necessary because the requirement itself is too subjective and not based on a clear compliance threshold.
3 For example, there is no clear indication what “predominantly” means. There is no direction on how many cylinders
4 to test or what statistical methods to employ in determining the meaning of “predominantly.”
5 The Submitter requested Voting status for this proposal.

6 An opposing argument may be that the paragraph is needed in order to protect consumers from fraud due to a scheme
7 undertaken by sellers or retail propane and the manufacturers of cylinders. The rebuttal to that argument is that in
8 effect, this rule in Handbook 130 is skewed against retail sellers of propane and by its very nature alleges that there is
9 collusion between cylinder manufacturers and retail propane marketers. Such an argument does not take into
10 consideration the variances in raw materials, the tolerances that manufacturers can achieve, or any number of factors
11 that address the very usefulness of a tare weight marking in the modern world of filling a cylinder with liquefied
12 petroleum gas.

13 The submitter requested that this be a voting item in 2024 and a retroactive requirement, enforceable to all devices.

14 **Comments in Favor:**

15 **Regulatory:**

- 16 •

17 **Industry:**

- 18 •

19 **Advisory:**

- 20 •

21 **Comments Against:**

22 **Regulatory:**

- 23 •

24 **Industry:**

- 25 •

26 **Advisory:**

- 27 •

28 **Neutral Comments:**

29 **Regulatory:**

- 30 •

31 **Industry:**

- 32 •

33 **Advisory:**

- 34 •

35 **Item Development:**

36 New Proposal

37 **Regional Associations’ Comments:**

38 New Proposal

1 Additional letters, presentation and data may have been submitted for consideration with this item. Please refer to
2 <https://www.ncwm.com/publication-15> to review these documents.

MOS-24.3
Regional recommendation to NCWM on item status: <input type="checkbox"/> Recommend as a Voting Item on the NCWM agenda <input checked="" type="checkbox"/> Recommend as an Information Item on the NCWM agenda <input type="checkbox"/> Recommend as an Assigned Item on the NCWM agenda <i>(To be developed by an NCWM Task Group or Subcommittee)</i> <input type="checkbox"/> Recommend as a Developing Item on the NCWM agenda <i>(To be developed by source of the proposal)</i> <input type="checkbox"/> Recommend Withdrawal of the Item from the NCWM agenda <i>(In the case of new proposals, do not forward this item to NCWM)</i> <input type="checkbox"/> No recommendation from the region to NCWM <i>(If this is a new proposal, it will not be forwarded to the national committee by this region)</i>
Comments and justification for the regional recommendation to NCWM: <i>(This will appear in NCWM reports)</i> No comments were heard. Because of no comments, the committee recommends this item be informational.

3

4 **MOS-24.4** **2.16.3.1. Tare Weights, Part (e) Tare Determination.**

5 **Source:**
6 National Propane Gas Association

7 **Purpose:**
8 Modify a requirement to recognize the variety of practices that are commonly used to protect valves on cylinders and
9 label cylinders with information.

10 **Item under Consideration:**
11 Amend the Uniform Regulation for the Method of Sale of Commodities as follows:

12 **2.16.3.1. Tare weights.**

13 ...

14 e) Tare Determination. – The stamped or stenciled tare weight shall be used for purposes of verifying the net
15 contents unless the actual tare weight is determined, then the actual tare weight shall be used for purposes of
16 net content verification. The removable protective cap and label are not included in the stamped or stenciled
17 tare but ~~must~~ can be included in the total tare determinations.

18 **Previous Status:**
19 2024: New Proposal

20 **Original Justification:**
21 The modification proposed to (e) is necessary because this text is confusing. Sometimes the protective cap for a
22 cylinder is attached by a plastic lanyard to the valve and is not easily removed. Other times, it is removeable.

1 Sometimes the “label” is actually a sleeve and it must be removed prior to filling the cylinder. Other times it is adhered
2 to the cylinder and cannot be removed easily.

3 An opposing argument may be that the paragraph is needed in order to protect consumers from fraud due to a scheme
4 undertaken by sellers or retail propane and the manufacturers of cylinders. The rebuttal to that argument is that in
5 effect, this rule in Handbook 130 is skewed against retail sellers of propane and by its very nature alleges that there is
6 collusion between cylinder manufacturers and retail propane marketers. Such an argument does not take into
7 consideration the variances in raw materials, the tolerances that manufacturers can achieve, or any number of factors
8 that address the very usefulness of a tare weight marking in the modern world of filling a cylinder with liquefied
9 petroleum gas.

10 The submitter requested that this be a voting item in 2024 and a retroactive requirement, enforceable to all devices.

11 **Comments in Favor:**

12 **Regulatory:**

- 13 •

14 **Industry:**

- 15 •

16 **Advisory:**

- 17 •

18 **Comments Against:**

19 **Regulatory:**

- 20 •

21 **Industry:**

- 22 •

23 **Advisory:**

- 24 •

25 **Neutral Comments:**

26 **Regulatory:**

- 27 •

28 **Industry:**

- 29 •

30 **Advisory:**

- 31 •

32 **Item Development:**

33 New Proposal

34 **Regional Associations’ Comments:**

35 New Proposal

36 Additional letters, presentation and data may have been submitted for consideration with this item. Please refer to
37 <https://www.ncwm.com/publication-15> to review these documents.

MOS-24.4	
Regional recommendation to NCWM on item status:	
<input type="checkbox"/> Recommend as a Voting Item on the NCWM agenda	
<input checked="" type="checkbox"/> Recommend as an Information Item on the NCWM agenda	
<input type="checkbox"/> Recommend as an Assigned Item on the NCWM agenda <i>(To be developed by an NCWM Task Group or Subcommittee)</i>	
<input type="checkbox"/> Recommend as a Developing Item on the NCWM agenda <i>(To be developed by source of the proposal)</i>	
<input type="checkbox"/> Recommend Withdrawal of the Item from the NCWM agenda <i>(In the case of new proposals, do not forward this item to NCWM)</i>	
<input type="checkbox"/> No recommendation from the region to NCWM <i>(If this is a new proposal, it will not be forwarded to the national committee by this region)</i>	
Comments and justification for the regional recommendation to NCWM: (This will appear in NCWM reports)	
No comments were heard.	
Because of no comments, the committee recommends this item be informational.	

1

2 **MOS-24.5** **2.27. Pet Treats or Chews.**

3 **Source:**

4 American Pet Products Association

5 **Purpose:**

6 Include count as an optional method of sale for pet treats or chews.

7 **Item under Consideration:**

8 Amend the Uniform Regulation for the Method of Sale of Commodities as follows:

9 **2.37. Pet Treats or Chews.** – Digestive chews, rawhides, bones, biscuits, antlers or similar type
10 products shall be sold by weight **or by count.**
11 (Effective July 18, 2019. Enforceable January 1, 2022)
12 (Added 2018) (Amended 2019, **20XX**)

13 **Previous Status:**

14 2024: New Proposal

1 **Original Justification:**

2 See the joint letter at <https://www.ncwm.com/publication-15> dated June 12, 2023 – Daniel Drake, State of NJ,
3 referencing NIST as noted in correspondence – “In this example [Consumer Packages – Specifically required in
4 section 2.3.7 (pet Treats or chews or similar products shall be sold by weight)], rawhide chews, due to the variability
5 in the thickness of the raw hide itself, can be packaged stating an accurate numerical count, however it is not possible
6 nor practical to label products listing Net Mass or Net Weight. The variability of the raw material (the raw hide) used
7 in the production of these products does not allow for consistent weight of the package to be listed as bags are pre-
8 printed before they are filled and sealed.

9 We would not see an opposing argument since this change is specific to pet treats and is very likely an unintended
10 consequence impacting a specific industry segment which sets an unachievable standard due to normal process
11 variation.

12 **Comments in Favor:**

13 **Regulatory:**

- 14
 -

15 **Industry:**

- 16
 -

17 **Advisory:**

- 18
 -

19 **Comments Against:**

20 **Regulatory:**

- 21
 -

22 **Industry:**

- 23
 -

24 **Advisory:**

- 25
 -

26 **Neutral Comments:**

27 **Regulatory:**

- 28
 -

29 **Industry:**

- 30
 -

31 **Advisory:**

- 32
 -

33 **Item Development:**

34 New Proposal

35 **Regional Associations’ Comments:**

36 New Proposal

37 Additional letters, presentation and data may have been submitted for consideration with this item. Please refer to
38 <https://www.ncwm.com/publication-15> to review these documents.

MOS-24.5	
Regional recommendation to NCWM on item status:	
<input type="checkbox"/> Recommend as a Voting Item on the NCWM agenda <input type="checkbox"/> Recommend as an Information Item on the NCWM agenda <input type="checkbox"/> Recommend as an Assigned Item on the NCWM agenda <i>(To be developed by an NCWM Task Group or Subcommittee)</i> <input type="checkbox"/> Recommend as a Developing Item on the NCWM agenda <i>(To be developed by source of the proposal)</i> <input checked="" type="checkbox"/> Recommend Withdrawal of the Item from the NCWM agenda <i>(In the case of new proposals, do not forward this item to NCWM)</i> <input type="checkbox"/> No recommendation from the region to NCWM <i>(If this is a new proposal, it will not be forwarded to the national committee by this region)</i>	
Comments and justification for the regional recommendation to NCWM: <i>(This will appear in NCWM reports)</i>	
<p>Steve Peter, Wisconsin commented that this item became enforceable in January 2022. Mr. Peter spoke with the original submitter and he recommends reviewing previous comments before taking a position on this item. Mike Harrington, Iowa concurs. He believes it is difficult for consumers to compare net weight and count. He does not think count is a definable weights and measures terms. Mr. Harrington opposes this item.</p> <p>The committee agrees this change is not necessary and will not allow consumer comparison. The committee recommends withdrawal.</p>	

1

2 **RSA – UNIFORM REGULATION FOR THE VOLUNTARY REGISTRATION OF**
 3 **SERVICE PERSONS AND SERVICE AGENCIES FOR COMMERCIAL**
 4 **WEIGHING AND MEASURING DEVICES**

5 **RSA-24.1 Section 4. Voluntary Registration**

6 **Source:**
 7 Arkansas Bureau of Standards

8 **Purpose:**
 9 Add the requirement that a Service Agent or individuals employed by a Service Agency must possess certificates
 10 demonstrating basic competency in applying applicable Handbook 44, 130, and 112 requirements.

11 **Item under Consideration:**
 12 Amend Handbook 130 Uniform Regulation for the Voluntary Registration of Service Persons and Service Agencies
 13 for Commercial Weighing and Measuring Devices as follows:

14 **Section 4. Voluntary Registration**

15 An individual or agency qualified by, **training or experience, and certificate(s) granted by a standards**
 16 **development organization recognized by the Director;** may apply for registration to service weighing devices
 17 or measuring devices on an application form supplied by the Director. Said form, duly signed and witnessed, shall
 18 include ~~certification guarantee~~ by the applicant that the individual or agency is fully qualified to install, service,
 19 repair, or recondition whatever devices for the service of which competence is being registered; has in possession
 20 or available for use, and will use, all necessary testing equipment and standards; and has full knowledge of all
 21 appropriate weights and measures laws, orders, rules, ~~and~~ regulations, **and policies.** An ~~applicant~~ **individual or**
 22 **each individual of an agency** ~~also~~ shall submit appropriate **certificate(s), evidence, or references as to**
 23 **qualifications.** **The certificate(s) shall apply to the types of weighing devices and measuring devices inspected**

1 **and tested by the individual or agency. Device types without available certificate(s) may be exempted.**
2 Application for registration shall be voluntary, but the Director is authorized to reject or limit any application.
3 (Added 1966) (Amended 1984) **(Amended 20XX)**

4 **Previous Status:**

5 2024: New Proposal

6 **Original Justification:**

7 Mandating an assessment of an individual’s knowledge, on weighing and measuring devices, will verify competency
8 and serve as a tool to increase consistency of services offered to owner/operators. This process is inconsistently
9 accomplished, nationwide, throughout jurisdictions.

10
11 The addition of this wording was not possible until the recent creation of Registered Service Agent Testing through
12 the National Conference on Weights and Measures (NCWM). By placing the testing and certificates, into a single
13 location(s), jurisdictions will not have to individually implement core knowledge assessment. Note, this DOES NOT
14 restrict jurisdictions from implementing additional testing, which can also be added through NCWM. Centralization
15 of core knowledge testing creates a uniform knowledge assessment that benefits NCWM membership and
16 owner/operators. This knowledge base would then be consistent across the country and membership could change as
17 needed through the Professional Development Committee.

18
19 Adoption of this language also serves to guarantee that certificates could be accepted in all jurisdictions, benefitting
20 Service Agents. Core or specific competency requirements could be achieved for multiple jurisdictions at one location
21 or in a shorter time. Alternative proctoring compounds this savings even more by allowing testing almost anywhere.
22 Each of these steps will cut cost and time investment of onboarding. This new testing will give Service Agent’s a
23 “one stop shopping” option in demonstrating knowledge and gaining registration in multiple jurisdictions.

24 The submitter presented the following potential arguments with responses:

25 Associated Cost – Testing through NCWM will cause a financial burden.

26 NCWM has set forth to make the testing reasonably affordable. Associated cost for multi-state travel, missed
27 work, technician pay, and others should offset testing cost.

28
29 Using the wording “certificate(s) granted by a standards development organization recognized by the Director”.

30 Though NCWM is the only organization to currently have this option available, it is not the intent to preclude
31 certificates from any other organization that may be recognized or those created by jurisdictions. Including
32 only “NCWM certificates” could be seen as limiting the options available in the future.

33
34 Immediately being enforceable

35 Submitter would defer to jurisdictional authority on implementation. Reasonable effort should be given to
36 educate and train Service Agents as to the requirement and location of the testing. Creating effective dates or
37 changing requirements on applications should create reasonable accommodations to the industry. Centralized
38 testing will create an even greater advantage, as Service Agents will only have to accomplish the action once.

39
40 Difficulty in ability to attain certificate.

41 This may be an unintended consequence that presents itself with opportunity. Inability to pass the test will
42 create an opportunity of jurisdictions to better educate and train those individuals. In turn this creates a better
43 Service Agent and provides more consistent and correct service to owner/operators.

44 Lack of training by Service Agents

45 Another consequence that may present opportunity. This could create a marketplace for training. Whether this
46 is taken up by individual, jurisdictions, industry, or NCWM it could become the catalyst for increasing
47 education and provide higher quality service.

1
2
3
4
5
6
7
8
9
10
11
12
13
14
15
16
17
18
19
20
21
22
23
24
25
26
27
28
29
30
31
32
33
34
35
36
37
38

Lack of mandatory testing for Inspectors

Some service companies may take issue with no policy providing for mandated inspector/investigator testing. The model law does not have an inspector provision; therefore, it cannot be amended. Jurisdictions should have training and accountability programs in place to ensure inspector/investigator knowledge. Professional certification through NCWM does not serve as core competency for inspectors/investigators, rather it provides “confidence that an individual has a strong understanding of U.S. weights and measures standards as adopted by NCWM and published in Handbooks 44, 130, and 133” (NCWM website).

Service Agent testing is meant to only establish core competency in reading of the handbooks and being able to use the appropriate material when inspecting and testing devices. The certificates issued will NOT be considered “Professional Certification”.

Recourse is available by submitting a Form 15 with any proposed changes or creation of model law to include inspector/investigator requirements. Service Agents can go through the exact same process and be heard.

The submitter requested Voting status for 2024.

Comments in Favor:

Regulatory:

-

Industry:

-

Advisory:

-

Comments Against:

Regulatory:

-

Industry:

-

Advisory:

-

Neutral Comments:

Regulatory:

-

Industry:

-

Advisory:

-

Item Development:

1 New Proposal

2 **Regional Associations’ Comments:**

3 New Proposal

4 Additional letters, presentation and data may have been submitted for consideration with this item. Please refer to
 5 <https://www.ncwm.com/publication-15> to review these documents.

RSA-24.1
<p>Regional recommendation to NCWM on item status:</p> <p><input type="checkbox"/> Recommend as a Voting Item on the NCWM agenda</p> <p><input checked="" type="checkbox"/> Recommend as an Information Item on the NCWM agenda</p> <p><input type="checkbox"/> Recommend as an Assigned Item on the NCWM agenda <i>(To be developed by an NCWM Task Group or Subcommittee)</i></p> <p><input type="checkbox"/> Recommend as a Developing Item on the NCWM agenda <i>(To be developed by source of the proposal)</i></p> <p><input type="checkbox"/> Recommend Withdrawal of the Item from the NCWM agenda <i>(In the case of new proposals, do not forward this item to NCWM)</i></p> <p><input type="checkbox"/> No recommendation from the region to NCWM <i>(If this is a new proposal, it will not be forwarded to the national committee by this region)</i></p>
<p>Comments and justification for the regional recommendation to NCWM: <i>(This will appear in NCWM reports)</i></p> <p>No comments were heard.</p> <p>The committee recommends this item be made informational and needs more input. The committee also questions the definition of “guarantee” by the applicant. The word “verification” may be better suited. This is found in section 4 Voluntary Registration.</p>

6

7 **FLR – UNIFORM FUELS AND AUTOMOTIVE LUBRICANTS REGULATION**

8 **FLR-23.3 D Section 2.20. Hydrogen Fuel.**

9 **Source:**

10 Quong and Associates

11 **Purpose:**

12 Add equivalent hydrogen quality standard, ISO 14687 to 2.20.

13 **Item under Consideration:**

14 Amend Handbook 130 Uniform Fuels and Automotive Lubricants Regulation as follows:

15 **2.20. Hydrogen Fuel.** – Shall meet the latest version of SAE J2719, “Hydrogen Fuel Quality for Fuel Cell
 16 Vehicles.” **or ISO14687 “Hydrogen fuel quality — Product specification”.**
 17 (Added 2012) **(Amended 20XX)**

18 **Previous Action:**

19 2023: Developing Item

1 **Original Justification:**

2 As hydrogen fuel cell vehicles expand worldwide, the codes and standards that support them have also moved to an
3 international stage. Currently, most of the hydrogen quality requirements for fuel cell vehicles have occurred under
4 the International Organization for Standardization (ISO) 14687 “Hydrogen fuel quality — Product specification”. The
5 latest revision of ISO 14687 occurred in 2019, and SAE 2719 was updated in 2020 to match. The attached document
6 compares the latest hydrogen fuel quality specifications in ISO 14687 2019 and SAE J2719 2020. Having both
7 requirements will allow the user of the station to use the most updated specification and ensure that fuel cell vehicles
8 are protected from contaminated fuel.

9 Some may argue that Argument: The updates in ISO 14687 could be considered a relaxation of the hydrogen quality
10 requirements. The submitter explained that the changes were made to provide flexibility for contaminants which could
11 not damage the fuel cell vehicle, or combinecontaminates with similar characteristics, such as inert gases or carbon
12 monoxide/formaldehyde/formic acid.

13 **Comments in Favor:**

14 **Regulatory:**

- 15 • 2023 Annual: None
16

17 **Industry:**

- 18 • 2023 Annual: None
19

20 **Advisory:**

- 21 • 2023 Annual: None
22

23 **Comments Against:**

24 **Regulatory:**

- 25 • 2023 Interim: Dr. Matt Curran, Florida opposed the item going forward with two standards.
26 • 2023 Interim: Mr. Doug Musick, Kansas and Austin Sheppard, County of San Diego concurred that only
27 one standard should be included.
28 • 2023 Interim: Ms. Vanesa Benchea, FALS Chair stated that two standards would be confusing. FALS
29 recommended there should be direction to reach out to stakeholders, industry and make this
30 informational.
31 • 2023 Interim: Mr. Kevin Schnepf, California: Concurs with FALS to keep it as informational.
32 • 2023 Interim: Mr. Austin Sheppard, County of San Diego stated he concurred with the previous
33 comments regarding two standards and suggests picking the more stringent of the two standards instead
34 of either.
35 • 2023 Interim: Mr. Ed Williams, Ventura County California stated he supports the comments made by
36 Austin Sheppard San Diego County including the date of the version of the standard. He also supported
37 the comments from Mr. Schnepf.

38 **Industry:**

- 39 • 2023 Annual: None
40

41 **Advisory:**

- 42 • 2023 Annual: None
43

44 **Neutral Comments:**

45 **Regulatory:**

- 46 • 2023 Annual: None

- 1
- 2 **Industry:**
- 3 • 2023 Annual: None
- 4
- 5 **Advisory:**
- 6 • 2023 Annual: None

7 **Item Development:**

8 NCWM 2023 Interim Meeting: The Committee, after hearing concern about the problems and confusion that will arise
 9 from citing two standards from Regulators and FALS Chair assigned Developing status to the item.

10 The Committee provides the following guidance to the Developer: Determine which standard is appropriate to resolve
 11 the issues derived from having two standards and update the Committee.

12 NCWM 2023 Annual Meeting: No comments were heard at the NCWM 2023 Annual meeting, and the Committee
 13 made no changes.

14 **Regional Associations’ Comments:**

15 WWMA 2022 Annual Meeting: Mr. Kevin Schnepf, CDFA/DMS, mentioned that the two systems, ISO and SAE are
 16 not always aligned. They are meant to be aligned but when changes are made those changes may be adopted at different
 17 times (example of 6-month gap in 2019). Also mentioned that the reference standards in the ISO are specifically
 18 section (d) of 14687, and this should be referenced specifically. He also mentioned that there may not be a need for
 19 this item. The Committee suggests the edits below.

20 **2.20. Hydrogen Fuel.** – Shall meet the latest version of SAE J2719, “Hydrogen Fuel Quality for Fuel Cell
 21 Vehicles.” **Or ISO14687 Grade (D) “Hydrogen fuel quality – Product specification”.**
 22 (Added 2012) **(Amended 20XX)**

23 The WWMA L&R Committee recommends Voting status with the above revisions based on the comments heard.

24 SWMA 2022 Annual Meeting: Dr. Matt Curran (Florida) commented that only one reference should be listed if
 25 equivalent. Listing both could cause confusion.

26 Ms. Lisa Warfield (NIST OWM) commented that Juana Williams (NIST OWM) is working with the Hydrogen
 27 National Work Group and should have an update by January 2023.

28 The Committee concurred with Dr. Curran that the item needs further development to determine which standard will
 29 be referenced and recommends it to be a Developing Item.

30 CWMA 2023 Annual Meeting: The CWMA recommend this item as Developing.

31 NEWMA 2023 Annual Meeting: The NEWMA recommend this item as Developing.

32 Additional letters, presentation and data may have been submitted for consideration with this item. Please refer to
 33 <https://www.ncwm.com/publication-15> to review these documents.

FLR-23.3	
Regional recommendation to NCWM on item status:	
<input type="checkbox"/> Recommend as a Voting Item on the NCWM agenda <input type="checkbox"/> Recommend as an Information Item on the NCWM agenda <input type="checkbox"/> Recommend as an Assigned Item on the NCWM agenda <i>(To be developed by an NCWM Task Group or Subcommittee)</i> <input checked="" type="checkbox"/> Recommend as a Developing Item on the NCWM agenda <i>(To be developed by source of the proposal)</i> <input type="checkbox"/> Recommend Withdrawal of the Item from the NCWM agenda <i>(In the case of new proposals, do not forward this item to NCWM)</i> <input type="checkbox"/> No recommendation from the region to NCWM <i>(If this is a new proposal, it will not be forwarded to the national committee by this region)</i>	
Comments and justification for the regional recommendation to NCWM: (This will appear in NCWM reports)	
No comments were heard.	
The committee recommends this item remain as developing until NIST and the developer are ready for it to proceed.	

1

2 **PPV – EXAMINATION PROCEDURE FOR PRICE VERIFICATION**

3 **PPV-24.1 Table 1. Samples, Sample Collection, and Accuracy Requirements**

4

5 **Source:**

6 Virginia Department of Agriculture and Consumer Services, Office of Weights and Measures

7 **Purpose:**

8 Clarification and modernization of antiquated reference.

9 **Item under Consideration:**

10 Amend Handbook 130 Examination Procedure for Price Verification as follows:

Table 1. Samples, Sample Collection, and Accuracy Requirements			
Column 1. Type of Store	Column 2. Samples	Column 3. Sample Collection Procedures	Column 4. Accuracy Requirements (See Section 10)
Convenience or Any Other Small Retail Store NOTE: For this procedure, a small store is typically one with three or fewer check-out registers.	Two-Stage Sample: First Stage = 25 items Second Stage = 25 items or more Total = 50 items or more or Single-Stage Sample: 50 items or more	Use the Randomized Sample Collection in 7.3.1 or the Stratified Sample Collection in 7.3.2. and Use Manual or Automated Inspection Procedures NOTE: Test the store as a whole unit by taking samples from all “areas” of the store,	If 1 error is found in the 25-item sample, test an additional 25 items. If more than 1 error is found in the 50-item sample, the store fails. NOTE: If more than 1 error is found in the first 25 items, the store fails.
	All Other Retail Stores	Two-Stage Sample: First Stage = 50 items Second Stage = 50 items or more Total = 100 items or more Single-Stage Sample: 100 or more items	or divide the store into “areas” and select samples from several “areas” (e.g., at least 10 or one-third of the “areas”) If 1 error is found in the 50-item sample, the store passes. If 2 errors are found in the 50-item sample, test an additional 50 items. If more than 2 errors are found in the 100-item sample, the store fails. NOTE: If more than 2 errors are found in either stage, the store fails. If more than 2 errors are found in the 100-item sample the store fails; or If more than 100 items are sampled, the error rate shall not exceed 2 %.

1
2 **Previous Status:**
3 2024: New Proposal

4 **Original Justification:**
5 Types of stores have changed through the years. Two examples to set the narrative, 1. Sheetz Gas Station- small
6 square footage, small amount of product with 3 cash registers and 3 self-check registers. 2. Dollar General Store-
7 large square footage, large amount of product, 1 cash register and 1 self-check register. To define Small Retail and
8 Large Retail Stores there must be better reference than the “check-out registers.”

9 The submitter stated the following: “I am aware of and open to any opposing argument and discussion. I have put
10 much thought into how I would define a small retail versus a large retail store. Other than my common sense I have

1 not decided on a clarification currently. My definition of a small or large retail store may be different than another's.
2 I feel there should be a definitive distinction in the examination procedure.”

3 The submitter requested Voting status for 2024.

4 **Comments in Favor:**

5 **Regulatory:**

- 6 •

7 **Industry:**

- 8 •

9 **Advisory:**

- 10 •

11 **Comments Against:**

12 **Regulatory:**

- 13 •

14 **Industry:**

- 15 •

16 **Advisory:**

- 17 •

18 **Neutral Comments:**

19 **Regulatory:**

- 20 •

21 **Industry:**

- 22 •

23 **Advisory:**

- 24 •

25 **Item Development:**

26 New Proposal

27 **Regional Associations' Comments:**

28 New Proposal

29 Additional letters, presentation and data may have been submitted for consideration with this item. Please refer to
30 <https://www.ncwm.com/publication-15> to review these documents.

1 include solvent evaporation, not just loss of water. For loss or gain of moisture, the moisture allowances
 2 may be applied before or after the package errors are determined.

3 To apply an allowance before determining package errors, adjust the Nominal Gross Weight (see Section
 4 2.3.6. “Determine Nominal Gross Weight and Package Errors”), so the package errors are increased by
 5 an amount equal to the moisture allowance. This approach is used to account for moisture loss in both the
 6 average and individual package errors.

7 It is also permissible to apply the moisture allowances after individual package errors and average errors
 8 are determined.

9 **Example:**

10 *A sample of a product that could be subject to moisture loss might fail because the average*
 11 *error is minus or the error in several of the sample packages are found to be unreasonable*
 12 *errors (i.e., the package error is greater than the Maximum Allowable Variation (MAV)*
 13 *permitted for the package’s labeled quantity).*

14 You may apply a moisture allowance after determining the package errors by adding the allowance to the
 15 Sample Error Limit (SEL) and then, comparing the average error to the SEL to determine compliance.
 16 The moisture allowance must be added to the MAV before evaluating sample errors to identify
 17 unreasonable minus errors.

18 (Amended 2010)

19 This handbook provides “moisture allowances” for some meat and poultry products, flour,
 20 pasta, **Cannabis (this only includes plant material but does not include products containing**
 21 **Cannabis** and dry pet food. (See Chapter 2, Table 2-3. “Moisture Allowances”) These allowances are
 22 based on the premise that when the average net weight of a sample is found to be less than the labeled
 23 weight, but not by an amount that exceeds the allowable limit, either the lot is declared to be within the
 24 moisture allowance or more information must be collected before deciding lot
 25 compliance or noncompliance.

26 Test procedures for flour, some meat, and poultry are based on the concept of a “moisture allowance” also
 27 known as a “gray area” or “no decision” area (see Section 2.3.8. “Moisture Allowances”). When the average
 28 net weight of a sample is found to be less than the labeled weight, but not more than the boundary of the
 29 “gray area,” the lot is said to be in the “gray” or “no decision” area. The gray area is not a tolerance. More
 30 information must be collected before lot compliance or noncompliance can be decided.

31 Appropriate enforcement should be taken on packages found short weight and outside of the “moisture
 32 allowance” or “gray area.”

33 (Amended 2002)

...Table 2-3. Moisture Allowances		
Verifying the labeled net weight of packages of:	Moisture Allowance is:	Notes
Flour	3 %	

Dry pet food	3 %	Dry pet food means all extruded dog and cat foods and baked treats packaged in Kraft paper bags and/or cardboard boxes with a moisture content of 13 % or less at time of pack.
Pasta products	3 %	Pasta products means all macaroni, noodle, and like products packaged in kraft paper bags, paperboard cartons, and/or flexible plastic bags with a moisture content of 13 % or less at the time of pack.
Borax	see Section 2.4. Borax	
<u>Cannabis</u>	<u>3 %</u>	<u>Cannabis means plant material only, and not products containing Cannabis, whether containing more than 0.3% Total Delta-9 THC (also known as Cannabis, Marijuana or Marihuana) or containing 0.3% or less Total Delta-9 THC (also known as Hemp).</u>
Wet Tare Only¹		
Fresh poultry	3 %	Fresh poultry is defined as poultry above a temperature of – 3 °C (26 °F) that yields or gives when pushed with the thumb.
Franks or hot dogs	2.5 %	
Bacon, fresh sausage, and luncheon meats	0 %	For packages of bacon, fresh sausage, and luncheon meats, there is no moisture allowance if there is no free-flowing liquid or absorbent material in contact with the product and the package is cleaned of clinging material. Luncheon meats are any cooked sausage product, loaves, jellied products, cured products, and any sliced sandwich-style meat. This does not include whole hams, briskets, roasts, turkeys, or chickens requiring further preparation to be made into ready-to-eat sliced product. When there is no free-flowing liquid inside the package and there are no absorbent materials in contact with the product, Wet Tare and Used Dried Tare are equivalent.
<p>¹Wet tare procedures must not be used to verify the labeled net weight of packages of meat and poultry packed at an official United States Department of Agriculture (USDA) facility and bearing a USDA seal of inspection. The Food Safety and Inspection Service (FSIS) adopted specific sections of the 2005 4th edition of NIST Handbook 133 by reference in 2008 but not the “Wet Tare” method for determining net weight compliance. FSIS considers the free-flowing liquids in packages of meat and poultry products, including single-ingredient, raw poultry products, to be integral components of these products (see Federal Register, September 9, 2008 [Volume 73, Number 175] [Final Rule – pages 52189-52193]).</p>		

- 1 **Previous Action:**
- 2 2022: Assigned - Cannabis Task Group
- 3 2023: Assigned - Cannabis Task Group

- 4 **Original Justification:**
- 5 Since *Cannabis* and *Cannabis*-containing products were first legalized by various states, the industry has undergone
- 6 an unprecedented expansion. Even though these products haven’t received Federal approval at this time, more and

1 more states have supported *Cannabis* and *Cannabis*- containing products for medicinal or adult use under their own
2 laws. This has resulted in boutique markets developing across the country with restrictive state boundaries for lack of
3 clarity and uniformity in commercialization of these products.

4 *Cannabis* and *Cannabis*- containing products are unique in many aspects; they have a niche as medicine, have resulted
5 in the development of adult use markets, and have an incredible array of different manufacturing and industrial
6 applications. Some of these products contain controlled substances which presents a special concern for the safety
7 and welfare of consumers if misused or mishandled. Further, they are subject to strict regulations by multiple
8 government agencies. *Cannabis* and *Cannabis*- containing products and applications range from non-food to food
9 products for human and animal consumption through inhalation, ingestion, and/or topical or dermal application. They
10 can be used as ingredients in other commodities, changing in most cases the product identity to *Cannabis* products.
11 Some *Cannabis* is very susceptible to environmental conditions easily losing or gaining moisture with consequences
12 impacting net quantity, degradation of active cannabinoids, and/or microbial proliferation depending on the situation.
13 These are just some of the reasons there are many concerns and uncertainty surrounding the moisture allowance of
14 *Cannabis*.

15 In the retail *Cannabis* trade, insufficient attention and guidance is given to moisture migration in or out of some
16 *Cannabis* packaging and as a result, the contents of some *Cannabis* flower packaging have been found to be
17 underweight, resulting in the patient/consumer paying for weight that they are not receiving. For instance, underweight
18 complaints are the #1 consumer complaint in Oregon. See attached table for data from multiple stores of four brands
19 and the incidence of underweight contents.

20 **Preview: If you were shopping any one of 3 stores of a popular brand you'd have a 71% chance of buying a**
21 **supposedly 1.75g package that is 21.6% underweight, meaning you have a 71% chance of being ripped off by**
22 **\$5 (assuming a \$10/g price). The lowest incidence of underweight? 54%. The lowest percent underweight?**
23 **2.75%**

24 For the fairness and safety of *Cannabis* consumers, a 3% +/- weight variance based on enforcement of acceptable
25 moisture range needs to be established. A 3% allowance aligns with other known commodities and with California
26 regulations that outline +/- 3%.

27 **Why 3%?** Consistent with other items in NIST handbook, aligns with California. If the boundaries are too wide, it
28 exposes the program to diversion.

29 **Is underweight really an issue?** I filed Public Records requests with every state that allows *Cannabis* flower
30 commerce. Each of them told me they keep no official records on underweight complaints. However, Oregon went
31 on record telling me underweight is one of their largest complaints (attached). As for one other state, see attached data
32 from Colorado that recorded 69 separate container purchases from 18 separate stores within 4 brands.

33 The submitter asked that this be a Voting Item in 2022.

34 **Comments in Favor:**

35 **Regulatory:**

- 36 • 2023 Interim: Mr. Craig Van Buren, Michigan, expressed support to move forward as a voting item, but
37 noted that they are still missing the data and have had issues getting the testing done. He recommended
38 that if the data doesn't support the proposal that it be withdrawn.

39 **Industry:**

- 40 • 2023 Annual: None

41 **Advisory:**

- 1 • 2023 Annual: None

2

3 **Comments Against:**

4 **Regulatory:**

- 5 • 2023 Annual: None

6

7 **Industry:**

- 8 • 2023 Annual: None

9

10 **Advisory:**

- 11 • 2023 Annual: None

12

13 **Neutral Comments:**

14 **Regulatory:**

- 15 • 2023 Interim: Mr. Vince Wolpert, Arizona stated that part of the study simulated environment. He
16 pointed out that there are a wide range of packaging options glass, wood, paper, plastic, foil, and that
17 best practices have not been developed yet for the cannabis industry.

18 **Industry:**

- 19 • 2023 Annual: None

20

21 **Advisory:**

- 22 • 2023 Interim: Mr. David Sefcik, NIST OWM stated that Cannabis is a schedule 1 controlled substance.
23 OWM recognizes the importance of this item and this time recommended that the item remain assigned
24 until a there is data to support it. He expressed concern with the positive moisture gain allowance stating
25 this allows a moisture gain up to 3% and the HB 133 doesn't allow for moisture gain. The proposal
26 should only address a negative error, not a positive error.

- 27 • 2023 Annual: Mr. Charlie Rutherford, representing the Cannabis Task Group as Co-Chair, updated the
28 Committee that the state of Michigan is performing tests and currently compiling data on moisture loss
29 allowances.

30 **Item Development:**

31 NCWM 2022 Interim Meeting: The Committee designated this item as Assigned at the 2022 NCWM Interim Meeting
32 and removed it from Block 3 (B3). The Committee referred it back to the NCWM Cannabis Task Group to conduct
33 a study relative to moisture loss allowance for Cannabis.

34 The Committee referred it back to the NCWM Cannabis Task Group to establish data supporting the moisture loss
35 allowance the Task Group recommended. The Committee heard concerns that should the current moisture loss
36 allowance be accepted without a study, the NCWM would be setting a precedence for future moisture loss allowance
37 requests. The Committee considered comments urging the Committee to move forward with the +/- 3 % moisture
38 loss allowance but believes it would be imprudent to accept a moisture loss allowance without supporting data.

1 The Committee is recommending the NCWM Cannabis Task Group to follow NIST Handbook 130, NCWM,
2 Interpretations and Guidelines section 2.5.6 Guidelines for NCWM Resolution of Requests for Recognition of
3 Moisture Loss in Other Packaged Products to establish the moisture allowances (loss and gain).

4 A request was made to the Cannabis Task Group for information and data supporting their proposed moisture loss
5 allowance, but as of the time of this writing it was not received.

6 The Committee assigned Voting status to items B3: PAL-22.1, B3: PAL 22.2 and B3: MOS-22-2 because they heard
7 support for these items and believe they are fully developed.

8 NCWM 2022 Annual Meeting: This item was originally included in Item Block 3 (B3) but was removed by the
9 Committee at the 2022 Annual meeting. Its status remains “Assigned”. The other items were “Voting” items.

10 The Committee heard from the Cannabis Task Group that work on studying moisture loss has begun. Cannabis Task
11 Group Co-Chair Charlie Rutherford informed the Committee that the Task Group is working with the State of
12 Michigan, a packaging company, and a cannabis provider to study moisture loss.

13 The Committee heard from Dave Sefcik, NIST, OWM during the open hearings. Mr. Sefcik shared the following
14 with the Committee: “In contrast to hemp, marijuana remains a Schedule I substance under the Controlled Substances
15 Act. NIST does not have a regulatory or policy role related to the production, sale, distribution, or use of cannabis
16 (including hemp and marijuana). NIST participates in the National Conference of Weights and Measures as part of
17 NIST’s statutory mission to promote uniformity in state laws, regulations, and testing procedures.”

18 The Committee considered the written NIST, OWM analysis published on the NCWM website prior to the NCWM
19 2022 Annual Meeting.

20 NCWM 2023 Interim Meeting: The Committee designated this item as Assigned and kept it assigned to the Cannabis
21 Task Group. The Committee encourages the conduct and completion of a study to determine the moisture allowance
22 and the information to be provided to the Committee. This information is necessary before the Committee can consider
23 the item as fully developed and move it forward as a Voting item.

24 NCWM 2023 Annual Meeting: The Committee received an update from the Cannabis Task Group and based on it,
25 made no changes.

26 **Regional Associations’ Comments:**

27 WWMA 2022 Annual Meeting: The WWMA L&R Committee did not solicit comments on this item, and
28 recommends this item continues as assigned to the NCWM Cannabis Task Group.

29 SWMA 2022 Annual Meeting: Mr. Charlie Rutherford (Co-chair of NCWM Cannabis Task Group and ASTM)
30 provided a quick update. A cannabis company is willing to give flower for free and Michigan will begin the testing
31 soon and anticipates an update to report at the January Annual meeting. The Committee recommends this item to
32 remain Assigned.

33 CWMA 2023 Annual Meeting: The CWMA recommended as an Assigned Item on the NCWM agenda

34 NEWMA 2023 Annual Meeting: The NEWMA recommended as an Assigned Item on the NCWM agenda.
35 Comments were heard from Mr. Charlie Rutherford, Co-Chair Cannabis Task Group. He noted that Craig Van Buren,
36 Michigan, is in the process of conducting a studying at MI’s lab that will provide insight to the task group on moisture
37 deviation above and below proposed thresholds. The results will be presented at the NCWM annual meeting in July.

38 Additional letters, presentation and data may have been submitted for consideration with this item. Please refer to
39 <https://www.ncwm.com/publication-15> to review these documents.

NET-22.1
<p>Regional recommendation to NCWM on item status:</p> <p><input type="checkbox"/> Recommend as a Voting Item on the NCWM agenda</p> <p><input type="checkbox"/> Recommend as an Information Item on the NCWM agenda</p> <p><input checked="" type="checkbox"/> Recommend as an Assigned Item on the NCWM agenda <i>(To be developed by an NCWM Task Group or Subcommittee)</i></p> <p><input type="checkbox"/> Recommend as a Developing Item on the NCWM agenda <i>(To be developed by source of the proposal)</i></p> <p><input type="checkbox"/> Recommend Withdrawal of the Item from the NCWM agenda <i>(In the case of new proposals, do not forward this item to NCWM)</i></p> <p><input type="checkbox"/> No recommendation from the region to NCWM <i>(If this is a new proposal, it will not be forwarded to the national committee by this region)</i></p>
<p>Comments and justification for the regional recommendation to NCWM: <i>(This will appear in NCWM reports)</i></p> <p>Greg VanderPlaats, Minnesota commented he believes the items should remain as an Assigned item until we have additional data.</p> <p>The committee agrees that the item should remain assigned to the task group.</p>

1

2 **NET-24.1 Section 3.11. Ice Cream Novelties.**

3 **Source:**

4 County of Los Angeles Department of Agriculture Commissioner/Weights and Measures

5 **Purpose:**

6 Add to the procedure and provide technical guidance on the preparation and maintenance of ice water at the required
7 temperature to test ice cream novelties such as ice cream bars, ice cream sandwiches, or cones.

8 **Item Under Consideration:**

9 Amend Handbook 133, Checking the Net Contents of Packaged Goods, as follows:

10 **3.11. ICE CREAM NOVELTIES**

11 Note: The following procedure can be used to test packaged products that are solid or semisolid and
12 that will not dissolve in, mix with, absorb, or be absorbed by the fluid into which the product will be
13 immersed. ~~For example, ice cream and frozen novelties~~ labeled by volume can be tested using
14 ~~ice~~ chilled water ~~or kerosene~~ as the immersion fluid.

15 Exception: Pelletized ice cream is beads of ice cream which are quick frozen with liquid nitrogen. The
16 beads are relatively small but can vary in shape and size. On April 17, 2009, the FDA issued a letter
17 stating that this product is considered semisolid food, in accordance with 21 CFR 101.105(a). The FDA
18 also addresses that the appropriate net quantity of content declaration for pelletized ice cream products
19 be in terms of net weight.

20 (Added 2010)

21 The following volume displacement procedure uses a displacement vessel specifically designed for ice
22 cream novelties such as ice cream bars, ice cream sandwiches, or cones. The procedure determines the
23 volume of the novelty by measuring the amount of water displaced when the novelty is submerged in
24 the vessel. Two displacements per sample are required to subtract the volume of sticks or cups.

1 The procedure first determines if the densities of the novelties are the same from package to package
2 (in the same lot) so that a gravimetric test can be used to verify the labeled volume. If a gravimetric
3 procedure is used, compute an average weight for the declared volume from the first two packages and
4 weigh the remainder of the sample. If the gravimetric procedure cannot be used, use the volume
5 displacement procedure for all of the packages in the sample.

6 **3.11.1. Test Equipment**

- 7 • A scale that meets the requirements in Section 2.2. “Measurement Standards and Test
8 Equipment”
- 9
- 10 • Volumetric measures
- 11
- 12 • Displacement vessel with dimensions appropriate for the size of novelties being tested (see
13 Figure 3-7(a), “Example of a Displacement Vessel”). It should include an interior baffle that
14 reduces wave action when the novelty is inserted and a downward angled overflow spout to
15 reduce dripping. Other designs may be used.



16 **Figure 3-7(a). Example of a Displacement Vessel.**

17
18
19

1
2
3
4
5
6
7
8
9
10
11
12

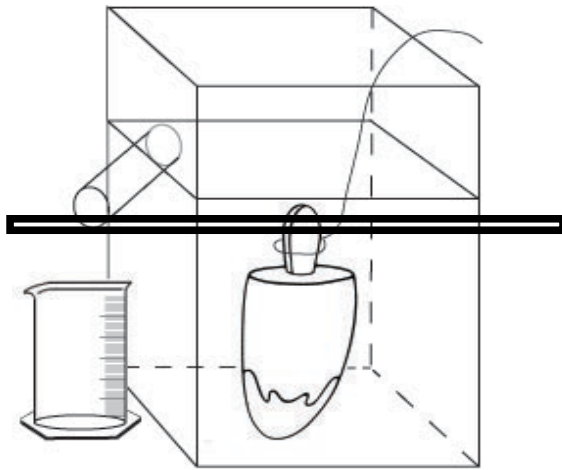

- **Insulation shield**

- **Minimum one inch thick Styrofoam board**

- **Styrofoam glue**

Use a minimum of one inch thick Styrofoam board to assemble the insulation shield. The insulation shield should be assembled with dimensions that will cover as much surface area of the displacement vessel and with as few gaps as possible (see Figure 3-7(b)(c)(d), “Example of an insulation shield with displacement vessel”).

1 **The purpose of this equipment is to reduce thermal transfer from ambient environment to the displacement**
2 **vessel in order to maintain the immersion fluid at 1 °C (33 °F) or below as consistently as possible during testing.**

3 **Figure 3-7(b)(c)(d). Example of an Insulation Shield with Acrylic Displacement Vessel.**

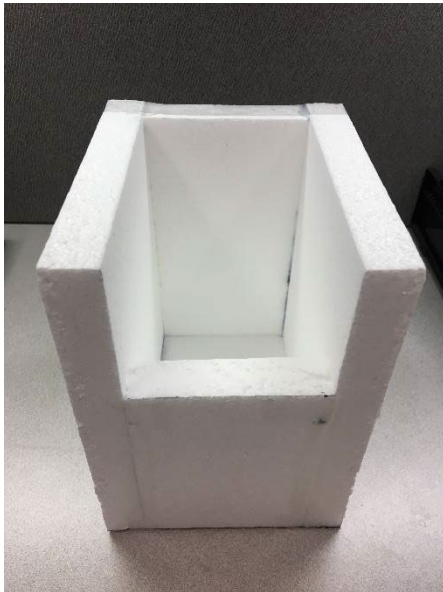

(b)



(c)

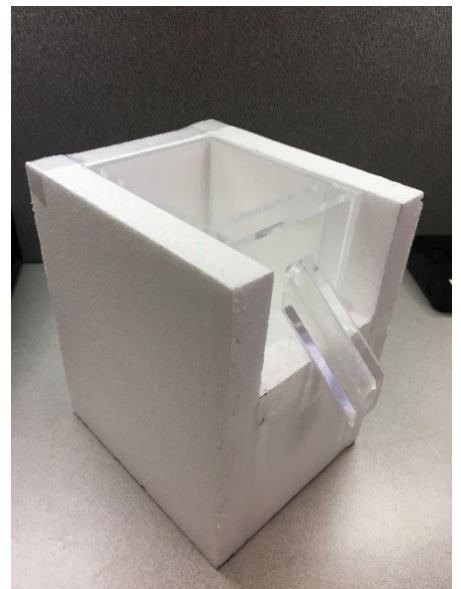

(d)

4 **Figure 3-7(b)(c)(d). Example of an Insulation Shield with Acrylic Displacement Vessel.**

5

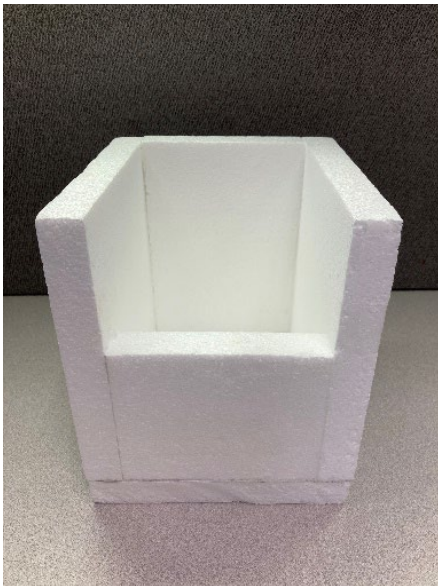

(e)



(f)

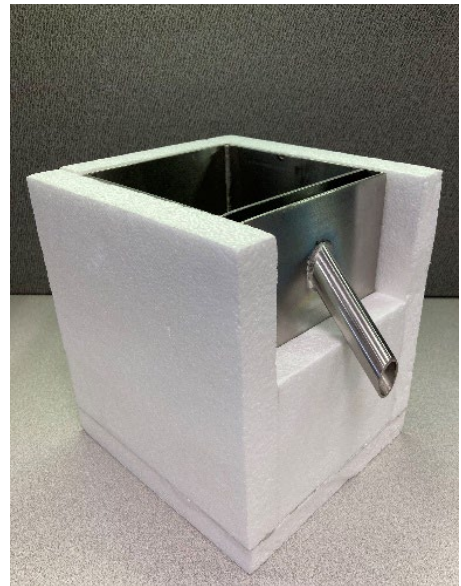

(g)

Figure 3-7(e)(f)(g). Example of an Insulation Shield with Metal Displacement Vessel

- Thin wire, clamp, or tongs
- Freezer or ice chest **containing and** dry ice
- Single-edged razor or sharp knife (for sandwiches only)
- **Prepared, chilled** water ~~/kerosene~~ maintained at 1 °C (33 °F) or below
 - **Water, ice cubes, dry ice, pitcher with insulation blanket**
- **Cryogenic gloves (for handling dry ice)**
- **Plastic Pitcher with insulation blanket**
- **Strainer**
- Indelible marker (for ice pops only)
- Level, at least 152 mm (6 in) in length
- Partial immersion thermometer or equivalent with 1 °C (2 °F) graduations and a – 35 °C to + 50 °C (– 30 °F to + 120 °F) accurate to ± 1 °C (± 2 °F)
- A tabletop, laboratory-type jack of sufficient size to hold the displacement vessel
- Stopwatch

3.11.2. Test Procedure

1. Follow the procedures in Section 2.3.1. “Define the Inspection Lot.” Use a “Category A” sampling plan in the inspection; and select a random sample.
2. <u>Place the displacement vessel and insulation shield in a freezer or an ice chest filled with dry ice for at least 30 minutes prior to testing. It is advisable to pre-chill water for use as immersion fluid in a sufficient volume to fill the displacement vessel and to replenish as needed throughout the testing procedures by placing a container of water in a refrigerator or ice chest during the same period.</u> Maintain the <u>ice cream or frozen novelty</u> samples at the reference temperature for frozen products that is specified in Table 3-1. “Reference Temperatures for Liquids.” Place the samples in the freezer or ice chest until they are ready to be tested, and then remove packages from the freezer one at a time.
3. According to the type of novelty, prepare the sample products as follows:
➤ <u>*Ice-pop.</u> Mark on the stick(s) with the indelible marker the point to which the ice-pop will be submerged in the <u>prepared, chilled</u> water. (After the ice-pop contents have been submerged, remove the novelty to determine the volume of the stick.)
➤ <u>*Cone.</u> Make a small hole in the cone below the ice cream portion to allow air to escape.
➤ <u>Sandwich.</u> Determine whether the declared volume is (a) the total volume of the novelty (that is, including the cookie portion) or (b) the volume of the ice-cream-like portion only. If the declared volume is the volume of only the ice-cream-like portion, shave off the cookie with a razor or knife, leaving some remnants of cookie to ensure that no ice cream is accidentally shaved off. Work quickly and return the novelty to the freezer before the sandwich softens.
➤ <u>Cup.</u> Remove the cap from the cup.

4. Prepare immersion fluid to a temperature of 1 °C (33 °F) or below by adding dry ice and ice cubes to water in a plastic pitcher.

For best results, wrap the pitcher with an insulation blanket to prevent heat transfer from the ambient environment. Monitor the water temperature throughout this procedure by placing the thermometer in the center position of the pitcher.

Note: Be cautious while handling dry ice due to its very low temperature (-109 °F); handle it with cryogenic gloves to prevent frostbite or freezer burns to skin.

Note: Dry ice (-109 °F) is the key ingredient for the chilled water immersion fluid preparation because of its very low temperature. However, while the dry ice lowers the water mixture temperature, the water surface that is in contact with the ambient air in the testing environment is also constantly gaining heat due to heat transfer. To resolve this problem, add ice cubes to the water; the ice cubes will float and form an insulation barrier, thereby, allowing water temperature to be maintained at the required temperature. The ratio to make the prepared, chilled water (can reach as low as 31.6 °F) are as follows:

Water : Dry ice : Ice cubes = 6 : 1 : 2

Note: Monitoring of the temperature of the chilled water immersion fluid should be conducted throughout the testing. At any time that the chilled water temperature exceeds 1 °C (33 °F), a new batch of chilled water at the required temperature will need to be prepared to validate the testing procedure.

5. When the displacement vessel and the insulation shield are both chilled and ready to be used, assemble them together (see Figure 3-7(b)(c)(d)).

6. 4. Fill the displacement vessel with ~~ice~~-prepared, chilled water until it overflows the spout. Use a strainer to prevent ice cubes or dry ice chunks from flowing into the displacement vessel. Allow it to sit until dripping stops. Raise the displacement vessel with a tabletop laboratory-type jack as necessary and place the graduate of appropriate capacity beneath the spout.

7.5. Remove a package from the freezer, determine its gross weight, and record it.

8.6. Submerge the novelty as suggested until it is below the surface level of the water.

➤ **Ice-pop.** Use a clamp, tongs, or your fingers to hold the stick(s) and submerge the ice-pop to the level marked in Step 3 of the Test Procedure.

➤ **Cone.** Shape the wire into a loop, and use it to push the cone, headfirst (ice cream portion first) into the **prepared, chilled** water. Do not completely submerge the cone immediately: let water fill the cone through the hole made in Step 3 of the Test Procedure before completely submerging the novelty.

➤ **Sandwich or cup.** Skewer the novelty with the thin wire or form a loop on the end of the wire to push the sandwich or ice cream portion or cup completely below the liquid level.

9.7. Record the total water volume in the graduate.

- For a cone or sandwich, record the water volume as the net volume and go to Step 9.
- For ice-pops or cups, record the water volume in the graduate as the gross volume and go to Step 8.

10.8. Refill the displacement vessel with **prepared, chilled water to overflowing and reposition the empty graduate under the spout. After the cup and novelty contents have been submerged, remove the novelty from the cup to determine the volume of the cup.**

<p>➤ Ice-pop. Melt the ice-pop off the stick or sticks. Submerge the stick or sticks to the line marked in Step 3. Record the volume of tare material (i.e., stick) by measuring the water displaced into the graduate. The net volume for the ice-pop is the gross volume recorded in Step 7 minus the volume of the tare materials in this step. Record this volume as the “volume of novelty.” To determine the error in the package, subtract the labeled quantity from the volume of novelty.</p>
<p>➤ Cup. Remove the novelty from the cup. Rinse the cup, and then submerge it in the displacement vessel. Small pinholes in the base of the cup can be made to make submersion easier. Record the volume of water displaced into the graduate by the cup as the volume of tare material. The net volume for the novelty is the gross volume determined in Step 7 minus the volume of the tare materials determined in this step. Record this as the net volume of the novelty. To determine the error in the package, subtract the labeled quantity from the volume of novelty.</p>
<p>11.9. Clean and air-dry the tare materials (sticks, wrappers, cup, lid, etc.). Weigh and record the weight of these materials for the package.</p>
<p>12.10. Subtract the tare weight from the gross weight to obtain the net weight and record this value.</p>
<p>13.11. Compute the weight of the labeled volume for the package using the following formula and then record the weight:</p> $\text{Product Density} = (\text{product net weight in Step 10}) \div (\text{the total water volume in Step 7} - \text{volume of tare material in Step 8})$ $\text{Weight of labeled volume} = (\text{labeled volume}) \times (\text{Product Density})$
<p>14.12. Repeat Steps 3 through 11 for a second package.</p>
<p>15.13. If the weight of the labeled volumes in Step 11 for the two packages differs from each other by more than one division on the scale, the gravimetric test procedure cannot be used to test the sample for compliance. If this is the case, use Steps 3 through 8 for each of the remaining packages in the sample to determine their net volumes and package errors. Then go to evaluation of results. If the weights of the labeled volumes agree within one division, continue to Step 14 to test the rest of the sample using the gravimetric test procedure.*</p>
<p>16.14. Use Section 2.3.5.1. “Determination of Tare Sample and Average Tare Weight” to determine the Average Used Dry tare Weight of the sample.</p>
<p>17.15. Find the Average Product Density by adding the densities of the product from the two packages and dividing the sum by two.</p>
<p>18.16. Using the weight of labeled volume determined in Step 11, calculate the Average Product Weight by multiplying the weight of the labeled volume by the average product density.</p> $\text{*Average Product Weight} = \text{Labeled Volume} \times \text{Average Product Density}$
<p>19.17. Calculate the “nominal gross weight” using the formula:</p> $\text{Nominal Gross Weight} = \text{Average Product Weight} + \text{Average Used Dry Tare Weight}$
<p>20.18. Weigh the remaining packages in the sample.</p>
<p>21.19. Subtract the nominal gross weight from the gross weight of each package to obtain package errors in terms of weight.</p>
<p>Note: Compare the sample packages to the nominal gross weight.</p>
<p>22.20. Determine the average package error by totaling all package errors and dividing by the number of packages in the sample.</p>
<p>To convert the average error or package error from weight to volume, use the following formula:</p>

$$\text{Package Error in Volume} = (\text{Package Error in Weight}) \div (\text{Average Product Density})$$

1 **3.11.3. Evaluation of Results**

2 Follow the procedures in Section 2.3.7. “Evaluate for Compliance” to determine lot conformance.

3 **Previous Action:**

4 2024: New Proposal

5 **Original Justification:**

6 The existing Handbook 133 procedure does not include guidance on the preparation of chilled water as an immersion
 7 fluid at the required temperature [1 °C (33 °F) or below]. As such, it can be difficult to maintain the immersion fluid
 8 for a reliable duration at the required temperature [1 °C (33 °F) or below] after the chilled water is poured into the
 9 displacement vessel. Water temperature exceeding 1 °C (33 °F) will result in the potential melting or softening of the
 10 ice cream or frozen novelty, thus resulting in inaccurate testing data and consequently invalidate or invite challenges
 11 to the inspection findings.

12 **Testing Data**

13 **Data Analysis and Summary Justification**

14 The following data summarizes the test of various materials for displacement vessels for this procedure. Materials
 15 considered were acrylic and metal in a variety of settings (ambient, with insulation, with insulation and prior chilling
 16 in freezer). These materials were chosen to reflect the variety used in typical, current displacement vessel fabrication.

17 The acrylic displacement vessel, combined with the insulation shield (with prior chilling), had the most favorable and
 18 reliable results for temperature stability. With the insulation and prior chilling, temperature stability in the acrylic
 19 displacement vessel significantly increased from 53 seconds of maintaining the temperature below 33.1 °F to 93
 20 minutes and 53 seconds.

21 **I. Displacement Vessel at Room Temperature (Without Insulation Shield)**

22

23 Data below recorded length of time that water temperature stayed below 33.1°F.

Tester Material	Time (min: sec)
Metal	00:00
Acrylic	00:53

24

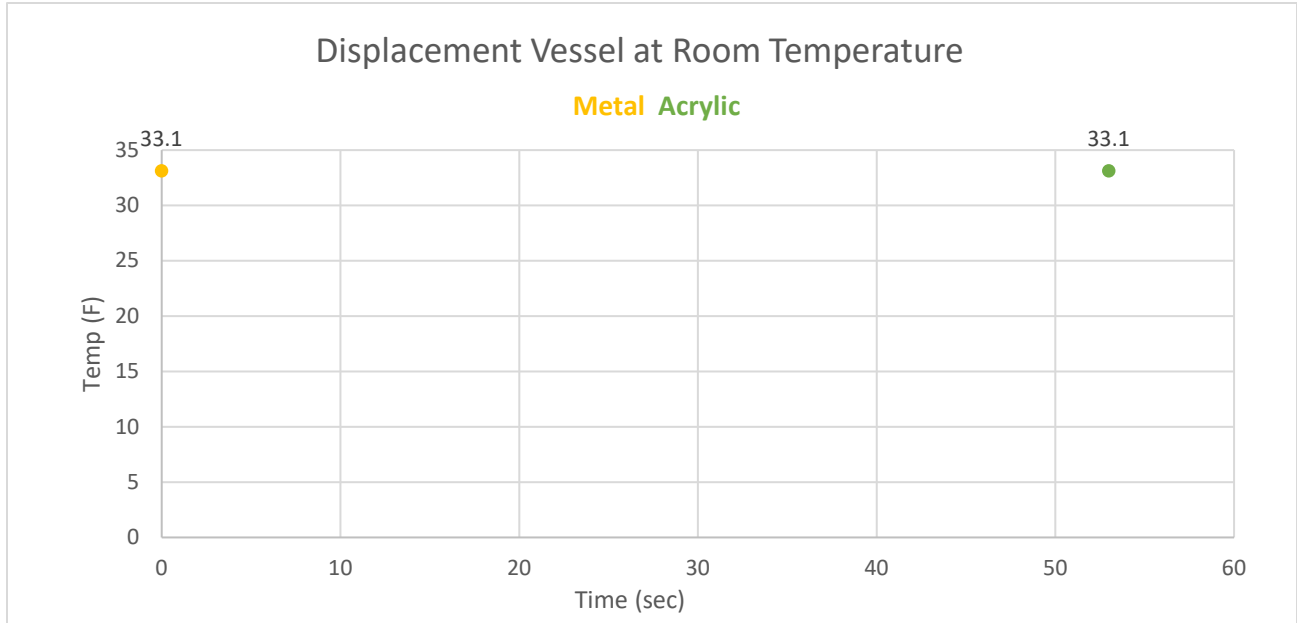

1

II. Displacement Vessel at Room Temperature (With Insulation Shield)

2
3

Data below recorded length of time that the water temperature stayed below 33.1°F.

4

Tester Material	Time (min: sec)
Metal	00:00
Acrylic	00:52

5

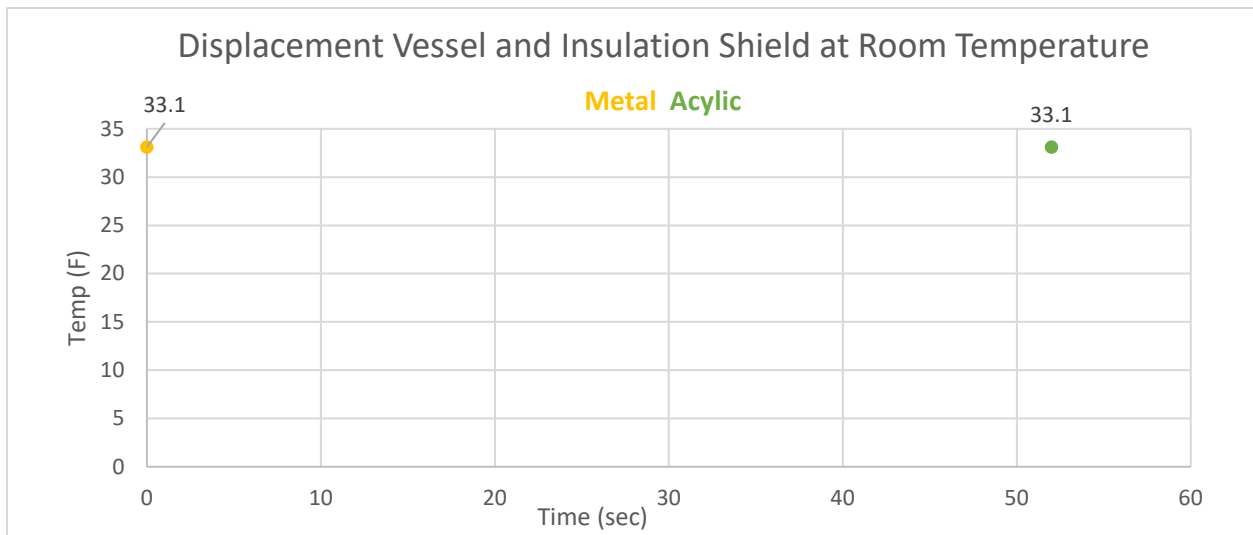

6
7

III. Displacement Vessel Chilled in Freezer for 30 minutes Prior to Test (Without Insulation Shield)

8
9
10

Prior to the testing, the displacement vessel was chilled in freezer prior to test for half an hour (30 mins). Data below recorded length of time that the water temperature stayed below 33.1°F.

Tester Material	Time (min: sec)
Metal	06:30
Acrylic	13:22

1

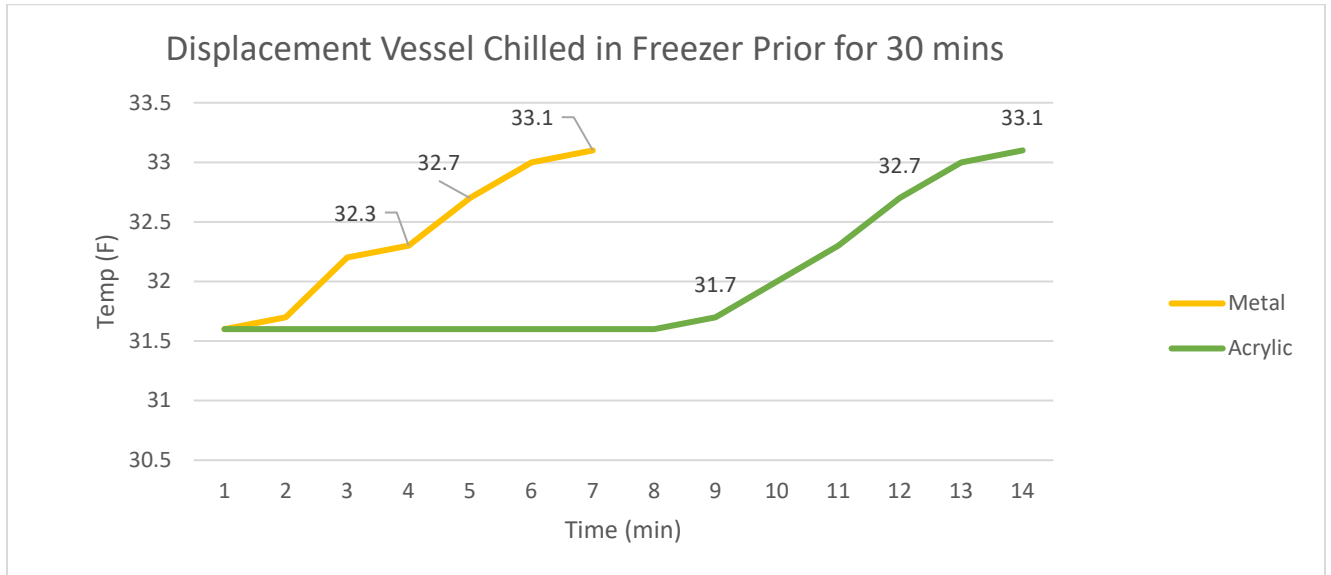

2

IV. Displacement Vessel and Insulation Shield Chilled in Freezer for 30 minutes Prior to Test

3

Prior to the testing, displacement vessel and insulation shield chilled in freezer for half an hour (30 mins). Data below recorded length of time that the water temperature stayed below 33.1°F.

4

5

Tester Material	Time (min: sec)
Metal	36:16
Acrylic	93:50

6

v.

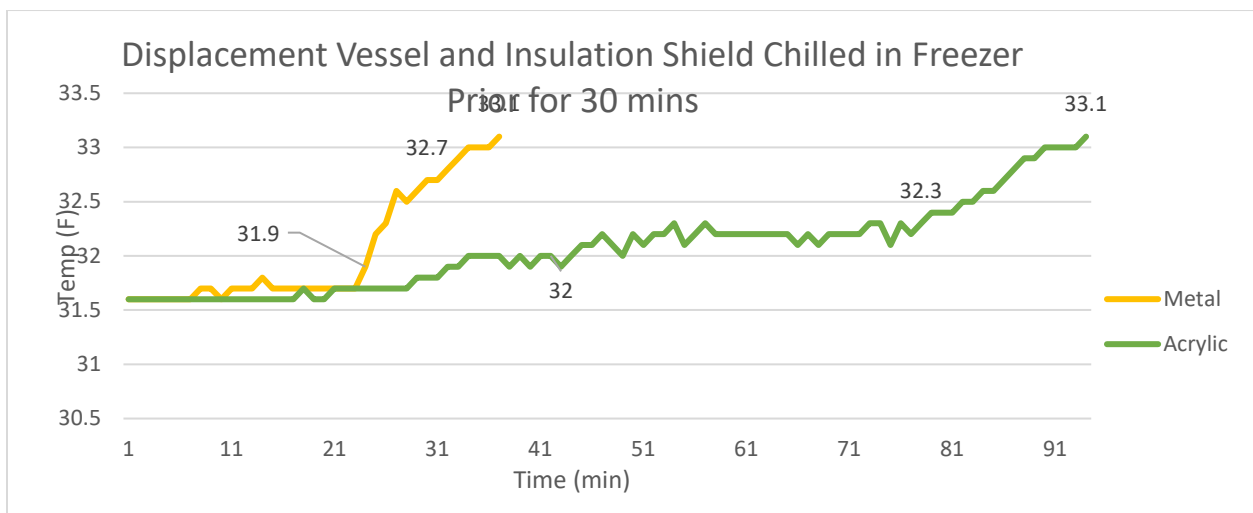

7

8

1 The submitter asked that this be an Informational Item in 2024.

2 **Comments in Favor:**

3 **Regulatory:**

- 4 •

5 **Industry:**

- 6 •

7 **Advisory:**

- 8 •

9 **Comments Against:**

10 **Regulatory:**

- 11 •

12 **Industry:**

- 13 •

14 **Advisory:**

- 15 •

16 **Neutral Comments:**

17 **Regulatory:**

- 18 •

19 **Industry:**

- 20 •

21 **Advisory:**

- 22 •

23 **Item Development:**

24 New Proposal

25 **Regional Associations' Comments:**

26 New Proposal

27 Additional letters, presentation and data may have been submitted for consideration with this item. Please refer to
28 <https://www.ncwm.com/publication-15> to review these documents.

NET-24.1

Regional recommendation to NCWM on item status:

- Recommend as a Voting Item on the NCWM agenda
- Recommend as an Information Item on the NCWM agenda
- Recommend as an Assigned Item on the NCWM agenda
(To be developed by an NCWM Task Group or Subcommittee)
- Recommend as a Developing Item on the NCWM agenda
(To be developed by source of the proposal)
- Recommend Withdrawal of the Item from the NCWM agenda
(In the case of new proposals, do not forward this item to NCWM)
- No recommendation from the region to NCWM
(If this is a new proposal, it will not be forwarded to the national committee by this region)

Comments and justification for the regional recommendation to NCWM: *(This will appear in NCWM reports)*

No comments were heard.

The committee recommends this item be informational for more comments to come in.

1

2 **NET-24.2 Section 4.9. Procedure for Checking the Contents of Specific Agriculture Seed**
3 **Packages Labeled by Count., and Appendix D. AOSA Rules for Testing**
4 **Seeds.**

5 **Source:**
6 Louisianan Department of Agriculture and Forestry

7 **Purpose:**
8 Align Chapter 4.9. Procedure for Checking the Contents of Specific Agriculture Seed Packages Labeled by Count
9 and Appendix D. AOSA Rules for Testing Seeds with recent changes to Association of Official Seed Analyst
10 (AOSA) Rules.

11 **Item Under Consideration:**
12 Amend Handbook 133, Checking the Net Contents of Packaged Goods, as follows:

13 4.9. Procedure for Checking the Contents of Specific Agriculture Seed Packages Labeled by Count

14
15 The following method shall be employed when using a mechanical seed counter to determine the number of seeds
16 contained in a sample of soybean (*Glycine max*), corn (*Zea mays*), wheat (*Triticum aestivum*) and field bean
17 (*Phaseolus vulgaris*) **and other seeds kinds. CAUTION: A mechanical seed counter may not be appropriate**
18 **to use for counting all seed kinds.**

19 4.9.2. Test Procedure

20 1. Testing samples shall be received and retained in moisture proof containers until the weight of the sample
21 prepared for purity analysis is recorded. The sample shall be of at least 500 grams for soybean, **and** field beans,
22 and 100 grams for wheat. **The sample weight for other seed kinds being tested shall be the weight of the**
23 **purity exam listed in AOSA Rules Volume 1 Table 2A.**

24 and

25
26 Appendix D. AOSA Rules for Testing Seeds
27 SECTION 12: MECHANICAL SEED COUNT

1 The following method shall be employed when using a mechanical seed counter to determine the number of seeds
2 contained in a sample of soybean (*Glycine max*), corn (*Zea mays*), wheat (*Triticum aestivum*) and field bean
3 (*Phaseolus vulgaris*) **and other seeds kinds. CAUTION: A mechanical seed counter may not be appropriate**
4 **to use for counting all seed kinds.**

5
6 12.1 Samples

7 Samples for testing shall be of at least 500 grams for soybean, corn and field beans and 100 grams for wheat. **The**
8 **sample weight for other seed kinds being tested shall be the weight of the purity exam listed in AOSA Rules**
9 **Volume 1 Table 2A, and All samples shall be** received in moisture proof containers. Samples shall be retained
10 in moisture proof containers until the weight of the sample prepared for purity analysis is recorded.

11
12 12.2 Seed counter calibration

13 ...

14 (b) Carefully pour the 1,000 seed calibration sample into the seed counter. Start the counter and run it until all the
15 seeds have been counted. The seeds should not touch as they run through the counter. Record the number of seeds
16 as displayed on the counter read out. The seed count should not vary more than +/- 2 seeds from 1,000. If the
17 count is not within this tolerance, clean the mirrors, adjust the feed rate and/or reading sensitivity. Rerun the
18 calibration sample until it is within the +/- 2 seed tolerance. If the seed counter continues to fail the calibration
19 procedure and the calibration sample has been checked to ensure that it contains 1,000 seeds, do not use the
20 counter until it has been repaired. **and then verified using the 1,000 seed calibration sample.**

21
22 **CAUTION: If the 1,000 seed calibration sample for a non-listed seed kind being counted always varies**
23 **more than the permitted +/- 2 seeds from 1,000, then the use of the mechanical seed counter is not**
24 **appropriate for that seed kind and must not be used for counting.**

25 **Previous Status:**

26 2024: New Proposal

27 **Original Justification:**

28 The primary purpose of this proposal is to clarify that the mechanical seed counting process (outlined in AOSA Rules
29 Vol.1 Section 12) may be used to determine the number of seeds contained in a sample of additional crop kinds not
30 listed. The mechanical seed counter must be proven it is fit for purpose (suitable) for seed kinds not listed, by using a
31 1,000 seed calibration sample of the seed kind under consideration. This proposal would provide a standardized
32 mechanical seed counter calibration procedure for all models of mechanical seed counters being used across the United
33 States, to determine the number of seeds per pound and/or for the purpose of packaging seeds by count

34 The submitter acknowledged the following:

35 1) Some mechanical seed counters have an automatic calibration feature that allows the device to automatically adjust
36 the settings to accurately count the seeds. Thus, there is no need to require mechanical seed counters to be calibrated
37 and/or verified using a 1,000 seed calibration sample.

38
39 2) AOSA Rules Volume 1 Section 14.9 only has maximum tolerances for comparing two seed count test results for
40 corn, field bean, soybean, and wheat. Two mechanical seed counts for seed kinds not listed cannot be compared since
41 there are no tolerances. Thus, there is no need to require mechanical seed counters to be calibrated using a 1,000 seed
42 calibration sample to confirm if the counter is suitable for use for kinds of seeds not listed in Section 14.9

1 **1. Wintersteiger Seed Counter S-25+**

2 <https://www.wintersteiger.com/us/Plant-Breeding-and-Research/Products/Product-range/Laboratory-preparation/66-Seed-Count-S-25plus>
3



4

5 **2. Agri-Instrument SLY-E High Accuracy Automatic Seed Counter**

6 <https://www.agri-instrument.com/wp-content/uploads/2018/05/SLY-E-High-Accuracy-Automatic-Seed-Counter.pdf>
7

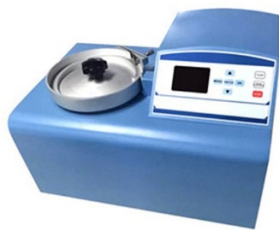

8

9

10

11 **3. Data Technologies DATA Count S-25 Plus**

12 <https://data-technologies.com/wp-content/uploads/2017/09/Seed-Counter-S-25.pdf>
13



14

15

16 **. Seedburo Count-A-Pak 801**

17 https://cdn.shopify.com/s/files/1/0070/8041/1191/files/801_Manual.pdf?v=1614276180
18



19

1
2
3
4
5
6

5. International Marketing and Design (IMD) Technologies Totalizer 750-2 C Series

<http://www.seedcounters.com/index.php/counting/summary?id=148>

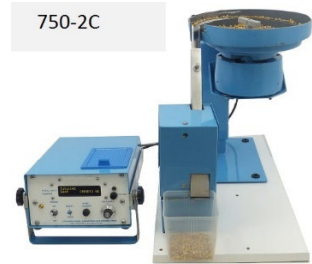

7
8
9
10
11
12

6. Pfeuffer Contador

<https://www.pfeuffer.com/product/contador>



13
14

15 The submitter requested Voting status for this item in 2024.

16 **Comments in Favor:**

17 **Regulatory:**

- 18
 -

19 **Industry:**

- 20
 -

21 **Advisory:**

- 22
 -

23 **Comments Against:**

1 **Regulatory:**
2 •

3 **Industry:**
4 •

5 **Advisory:**
6 •

7 **Neutral Comments:**

8 **Regulatory:**
9 •

10 **Industry:**
11 •

12 **Advisory:**
13 •

14 **Item Development:**
15 New Proposal

16 **Regional Associations' Comments:**
17 New Proposal

18 Additional letters, presentation and data may have been submitted for consideration with this item. Please refer to
19 <https://www.ncwm.com/publication-15> to review these documents.

NET-24.2
<p>Regional recommendation to NCWM on item status:</p> <p> <input type="checkbox"/> Recommend as a Voting Item on the NCWM agenda <input checked="" type="checkbox"/> Recommend as an Information Item on the NCWM agenda <input type="checkbox"/> Recommend as an Assigned Item on the NCWM agenda <i>(To be developed by an NCWM Task Group or Subcommittee)</i> <input type="checkbox"/> Recommend as a Developing Item on the NCWM agenda <i>(To be developed by source of the proposal)</i> <input type="checkbox"/> Recommend Withdrawal of the Item from the NCWM agenda <i>(In the case of new proposals, do not forward this item to NCWM)</i> <input type="checkbox"/> No recommendation from the region to NCWM <i>(If this is a new proposal, it will not be forwarded to the national committee by this region)</i> </p>
<p>Comments and justification for the regional recommendation to NCWM: (This will appear in NCWM reports)</p> <p>No comments were heard.</p> <p>The committee recommends this item be informational for more comments to come in.</p>

20

1 X.X. Freight Broker

2 The intermediary between the shipper and the carrier who facilitates the transportation of goods.

3 X.X. Quote

4 A competitively solicited written offer to furnish supplies or services by a method of procurement that is less
5 formalized than a bid or a proposal.

6 X.X. Bill of Lading (BOL)

7 A legal instrument used in the transportation and shipping industries which lists the goods being shipped and
8 the terms under which they will be delivered.

9 X.X. Progressive Number (Pro Number)

10 A series of numbers used by carriers to identify and then track a specific order tendered to a specific carrier.

11 X.X. Inspection Certificate

12 A document used to signify that shipped goods have been inspected pertaining, but not limited to,
13 classification, density, weight, or measure.

14 X.X Director. – The _____ of the Department of _____.

15 Section 4. Enforcing officer: Rules and Regulations

16 The Director is authorized to:

17 (a) enforce the provisions of this Act;

18 (b) issue reasonable regulations for the enforcement of this Act that shall have the force and effect of law;
19 and

20 (c) adopt rules that include, but are not limited to:

21 (1) adherence to quotes when correct documentation is provided to the carrier;

22 (2) weighing and measuring practices that must be followed;

23 (3) the required information to be submitted to the shipper if there is a correction fee applied; and

24 (4) the period of recordkeeping.

25 Section 5. Weighing and Measuring Practices and Equipment Used

26 A carrier shall use the following weighing and measuring practices and equipment:

27 (a) in accordance with the requirements of the latest edition of NIST Handbook 44, “Specifications,
28 Tolerances, and Other Technical Requirements for Weighing and Measuring Devices”; and

1 (b) examined, tested, and approved for use by a weights and measures officer of this state.

2 Section 6. Weighing Device Used:

3 A carrier shall use a scale in accordance with the manufacturer's approved application of the device.

4 Section 7. Measuring Device Used:

5 A carrier shall use a measuring device in accordance with the manufacturer's approved application of the
6 device.

7 Section 8. Inspection Certificate: Required Entries

8 (a) The documentation, when properly completed and signed shall be prima facie evidence of the accuracy
9 of the procedure followed and the recorded results.

10 (b) The design of and the information to be furnished on the documentation shall be prescribed by the
11 Director and will include, but not be limited to, the following:

12 (1) the name and employee ID# of the individual who conducts the inspection;

13 (2) date and time of the inspection;

14 (3) signature of the employee who conducts the inspection (digital signature accepted);

15 (4) identifying information of the weighing or measuring device used to conduct the inspection to include
16 the associated make, model, serial number, and Certificate of Conformance number, if applicable;

17 (5) indicated reweigh or remeasure value from the weighing device or measuring device;

18 (6) provide detailed information on the process used to reclassify a shipment according to type of goods
19 and/or shipment density;

20 (7) provide the dollar amount of the correction fee applied and the description of the fee;

21 (8) identifying information for the issuing terminal to include physical address and contact name of
22 terminal manager to include phone number and/or email address;

23 (9) identifying information for both the Pro Number and BOL, if applicable;

24 (10) the name and address of the shipper from point of origin;

25 (11) the tendered classification, density, weight, or measurement provided from the shipper and freight
26 broker, if applicable; and

27 (12) the declared classification, density, weight, or measurement determined by the carrier and freight
28 broker, if applicable.

29 Section 9. Copies of Inspection Certificates

1 The carrier shall keep and preserve for the period specified in the regulations a legible copy of each
2 inspection certificate issued to the shipper and freight broker, if applicable. The certificates shall be available
3 for inspection by any weights and measures officer during normal office hours.

4 Section 10. Prohibited Acts

5 No entity shall

6 (a) provide a false classification, density, weight, or measurement;

7 (b) violate any provisions of this Act or any regulation promulgated under this Act; or

8 (c) use or have in their possession a device which has been altered to facilitate fraud.

9 Section 11. Civil Penalties

10 11.1. Assessment of Penalties. – Any entity who by themselves or by their servant or agent commits any of the
11 acts enumerated in Section 14. Validity of Prosecutions may be assessed by the _____ a civil penalty of:

12 (a) not less than \$ nor more than \$ for a first violation,

13 (b) not less than \$ nor more than \$ for a second violation within from the date of the first violation, and

14 (c) not less than \$ nor more than \$ for a third violation within from the date of the first violation.

15 11.2. Administrative Hearing. – Any entity subject to a civil penalty shall have a right to request an
16 administrative hearing within _____ days of receipt of the notice of the penalty. The Director or their
17 designee shall be authorized to conduct the hearing after giving appropriate notice to the respondent. The
18 decision of the Director shall be subject to appropriate judicial review.

19 11.3. Collection of Penalties. – If the respondent has exhausted their administrative appeals and the civil
20 penalty has been upheld, they shall pay the civil penalty within _____ days after the effective date of the
21 final decision. If the respondent fails to pay the penalty, a civil action may be brought by the Director in any
22 court of competent jurisdiction to recover the penalty. Any civil penalty collected under this Act shall be
23 transmitted to _____.

24 Section 12. Criminal Penalties

25 12.1. Misdemeanor. – Any entity who by themselves or by their servant or agent commits any of the acts
26 enumerated in Section 10. Prohibited Acts or violates any other provision of this Act shall be guilty of a Class
27 _____ misdemeanor and upon conviction shall be punished by a fine not less than \$ _____, nor
28 more than \$ _____, or by imprisonment for not less than _____ nor more than _____, or
29 both fine and imprisonment.

30 12.2. Felony. – Any entity who by themselves or their servant or agent who intentionally commits any of the
31 acts enumerated in Section 1. Prohibited Acts or repeatedly violates any other provision of this Act shall be
32 guilty of a Class _____ felony and upon conviction shall be punished by a fine not less than \$ _____
33 and/or by imprisonment for not less than _____, nor more than _____.

34 Section 13. Restraining Order and Injunction

1 **The Director is authorized to apply to any court of competent jurisdiction for a restraining order, or a**
2 **temporary or permanent injunction, restraining any person from violating any provision of this Act.**

3 **Section 14. Validity of Prosecutions**

4 **Prosecutions for violation of any provision of this Act are declared to be valid and proper notwithstanding**
5 **the existence of any other valid general or specific Act of this state dealing with matters that may be the same**
6 **as or similar to those covered by this Act.**

7 **Section 15. Severability Provision**

8 **If any provision of this Act is declared unconstitutional, or the applicability thereof to any person or**
9 **circumstance is held invalid, the constitutionality of the remainder of the Act and the applicability thereof to**
10 **other persons and circumstances shall not be affected.**

11 **Section 16. Repeal of Conflicting Laws**

12 **All laws and parts of laws contrary to or inconsistent with the provisions of this Act, and specifically**
13 **_____ , are repealed insofar as they might operate in the future; but as to offenses committed, liabilities**
14 **incurred, and claims now existing there under, the existing law shall remain in full force and effect.**

15 **Section 17. Citation**

16 **This Act may be cited as the “Shipment Act of _____.”**

17 **Section 18. Effective Date**

18 **This Act shall become effective on _____.**

19 **Source:**

20 New Hampshire Department of Agriculture, Markets & Food

21 **Previous Status:**

22 2024: New Proposal

23 **Original Justification:**

24 Current shipping practices may result in incorrect overcharges and misleading pricing. It has been documented through
25 investigations that carriers or freight brokers have incorrectly billed shippers on goods shipped. Documentation
26 provided by carriers to both shippers and weights and measures officials lack relevant information needed to fully
27 investigate complaints within the shipping industry.

28 Carriers may have language in their contracts that inform the shipper of possible audits of their shipped goods and
29 subsequent correction and audit fees.

30 The submitter requested Voting status in 2024.

31 **Comments in Favor:**

32 **Regulatory:**

- 33
 -

34 **Industry:**

1 •

2 **Advisory:**

3 •

4 **Comments Against:**

5 **Regulatory:**

6 •

7 **Industry:**

8 •

9 **Advisory:**

10 •

11 **Neutral Comments:**

12 **Regulatory:**

13 •

14 **Industry:**

15 •

16 **Advisory:**

17 •

18 **Item Development:**

19 New Proposal.

20 **Regional Associations' Comments:**

21 New Proposal

22 Additional letters, presentation and data may have been submitted for consideration with this item. Please refer to
23 <https://www.ncwm.com/publication-15> to review these documents.

OTH-24.1

Regional recommendation to NCWM on item status:

- Recommend as a Voting Item on the NCWM agenda
- Recommend as an Information Item on the NCWM agenda
- Recommend as an Assigned Item on the NCWM agenda
(To be developed by an NCWM Task Group or Subcommittee)
- Recommend as a Developing Item on the NCWM agenda
(To be developed by source of the proposal)
- Recommend Withdrawal of the Item from the NCWM agenda
(In the case of new proposals, do not forward this item to NCWM)
- No recommendation from the region to NCWM
(If this is a new proposal, it will not be forwarded to the national committee by this region)

Comments and justification for the regional recommendation to NCWM: *(This will appear in NCWM reports)*

Mike Harrington, Iowa commented he does not fully understand the purpose of this item. He asks for clarification from the submitter. At this point he would recommend withdrawing the item because he doesn't understand how it relates to weights and measures.

The committee recommends withdrawal. More information is needed to clarify the intent of this item.

1

2 **OTH-07.1 D Fuels and Lubricants Subcommittee**

3 **Source:**

4 NCWM Fuels and Lubricants Subcommittee (FALS)

5 **Purpose:**

6 Provide an update of the activities of this Subcommittee which works on direction from and reports to the L&R
7 Committee. The mission of FALS is to assist the L&R Committee in the development of agenda items that affect
8 Handbook 130, Uniform Fuels and Automotive Lubricants Inspection Law and Uniform Fuels and Automotive
9 Lubricants Regulation. The Subcommittee consists of regulators and associate members who have subject matter
10 expertise in fuels and lubricants. The Subcommittee will be called upon to aid in the development, provide guidance,
11 and help establish NCWM position on items concerning fuels and lubricants.

12 **Item Development:**

13 NCWM 2023 Annual Meeting: Ms. Vanessa Benchea verbally updated the Committee. She also provided the
14 following written report on the activities of the Fuels and Lubricants Subcommittee (FALS) which reports and
15 provides recommendations to the Laws and Regulations Committee.

16 For more information or to provide comment, please contact the FALS Chair:

17 Ms. Vanessa Benchea
18 Florida Department of Agriculture and Consumer Services/Division of Consumer Services
19 (813) 868-8263, Vanessa.Benchea@fdacs.gov

20 FALS met on Sunday, July 30, 2023, at the 2023 NCWM Annual Meeting in Norfolk, VA to review items related to
21 fuel and automotive fluid standards that appear on the L&R agenda. Updates were provided for assigned Block items
22 1 & 6, proposed changes to item Block 2 were discussed and two new business items, Drag Reducing Agent in Retail
23 Diesel and Editorial Standards when referencing citations from Federal Government Agencies, were presented.

24 **For Item Block 1 (B1) Renewable Diesel and Diesel**, Chuck Corr (Corr Consulting) provided the latest developments
25 of this item to FALS which included language updates that resulted from the informal focus group. While there wasn't

1 full consensus of the language provided, FALS did feel that it was ready to advance to the regional committees and
 2 that it should be included in Publication 15. At this time the informal focus group is on hiatus until after the fall
 3 regional meetings where the group will then reconvene and discuss any changes that may be needed. Any updates to
 4 this proposal, will then be presented at the Interim.

5 **For Item Block 6 Transmission Fluid**, the Informal Focus Group chair, Joanna Johnson (Automotive Oil Change
 6 Association) provided a statement on behalf of the group that indicated that they could not agree on a practical
 7 approach to provide language for the original agenda item. They recommend this approach should no longer be
 8 pursued and the items be withdrawn. On behalf of the Informal Focus Group, Ms. Johnson also recommended that a
 9 new group with a focus on EV fluids be formed. There was no opposition from FALS for either recommendation.

10 **For Item Block 2 (B2) Gasoline:** Chuck Corr presented to the group several identified recommended changes to
 11 the Block 2 items in Publication 16 that had been suggested by the team at OWM. FALS recommends making these
 12 changes as suggested.

13 Mr. Brian Kernke (Love’s Travel Stores) presented information on the impacts that unsheared drag reducing agents
 14 have had on Love’s business and stated that there had also been impacts at retail stations as well as truck drivers. He
 15 indicated it was expensive to replace filters and the associated downtime at retail. Mr. Bill Striejewske (Nevada)
 16 indicated that they had seen these issues in Nevada and that it was causing dispensers to flow so slow that shutoffs
 17 weren’t working properly.

18 Chuck Corr (CC consulting) spoke on the proposed NIST established editorial standards in which he voiced his
 19 concerns on including the year regarding citations to Federal Government Agencies. There was general agreement
 20 from FALS that it should be the Name, Volume, Source Section xxx. FALS will request that dates are not included
 21 when referencing citations from federal government agencies.

22 **Item Block 6 (B6) Transmission Fluid**

23 The following statement was provided by Joanna Johnson (Automotive Oil Change Association), Transmission Fluid
 24 Focus Group Chair:

25 The Transmission Fluid Focus Group has devoted several years to investigating vehicle transmission fluid
 26 labeling. At this time, this focus group could not agree on a practical approach to designate certain
 27 transmission fluids as “obsolete” for a variety of reasons, including lack of a comprehensive and consistent
 28 standards setting organization mechanism, automakers’ ongoing use of older specifications, and the
 29 sufficiency of current NIST Handbook 130 requirements. Therefore, the original amendment approach in B6:
 30 MOS-21.1. A Section 2.36.2. *Labeling and Identification of Transmission Fluid* and B6: FLR-21.2. A Section
 31 3.14.1. *Labeling and Identification of Transmission Fluid* should no longer be pursued. The Focus Group
 32 proposes to switch efforts to developing consumer protection language for labels necessary to distinguish EV
 33 fluids from Fuel Cell vehicle fluids and traditional CEV coolant, as well as EV transmission fluids from gear
 34 oil.

35 With this feedback from the TFG, FALS recommends withdrawal of this block of items and formation of the new the
 36 focus group for EV fluids.

37 **Regional Associations’ Comments:**

38 WWMA 2022 Annual Meeting: The WWMA L&R Committee would like to thank the FALS for their report. The
 39 WWMA L&R Committee Recommends as a developing item on the NCWM Agenda.

40 SWMA 2022 Annual Meeting: No comments or updates were provided. The SWMA L&R Committee Recommends
 41 this as a developing item on the NCWM Agenda.

42 CWMA 2023 Annual Meeting: The CWMA recommended as a Developing Item on the NCWM agenda.

- 1 NEWMA 2023 Annual Meeting: The CWMA recommended as a Developing Item on the NCWM agenda.
2 Additional letters, presentation and data may have been submitted for consideration with this item. Please refer to
3 <https://www.ncwm.com/publication-15> to review these documents.

OTH-07.1
Regional recommendation to NCWM on item status: <input type="checkbox"/> Recommend as a Voting Item on the NCWM agenda <input type="checkbox"/> Recommend as an Information Item on the NCWM agenda <input type="checkbox"/> Recommend as an Assigned Item on the NCWM agenda <i>(To be developed by an NCWM Task Group or Subcommittee)</i> <input checked="" type="checkbox"/> Recommend as a Developing Item on the NCWM agenda <i>(To be developed by source of the proposal)</i> <input type="checkbox"/> Recommend Withdrawal of the Item from the NCWM agenda <i>(In the case of new proposals, do not forward this item to NCWM)</i> <input type="checkbox"/> No recommendation from the region to NCWM <i>(If this is a new proposal, it will not be forwarded to the national committee by this region)</i>
Comments and justification for the regional recommendation to NCWM: <i>(This will appear in NCWM reports)</i>
No comments were heard.
The committee recommends this remain developing.

4

5 **OTH-11.1 D Packaging and Labeling Subcommittee**

6 **Source:**

7 NCWM Packaging and Labeling Subcommittee (PALS)

8 **Purpose:**

9 Provide an update of the activities of this Subcommittee which reports to the L&R Committee. The mission of PALS
10 is to assist the L&R Committee in the development of agenda item, NCWM positions and new standards related to
11 packaging and labeling. The Subcommittee will also be called upon to provide important and much needed guidance
12 to the regulatory and consumer packaging communities on difficult questions. PALS will report to NCWM L&R
13 Committee. The Subcommittee is comprised of a Chair, eight voting members, and anyone interested in packaging
14 and labeling standards.

15 **Original Justification:**

16 This item is to provide a report on the activities of the Packaging and Labeling Subcommittee which reports and
17 provides recommendations to the Laws and Regulations Committee.

18 For more information or to provide comment, please contact the PALS Chair:

19 Mr. Chris Guay
20 CGGT
21 513-652-6597, guay.cb@gmail.com

1 PALS is comprised of four voting regulatory officials (one from each region) and four voting members from industry
 2 (retailers and manufacturers) in addition to its Chair and NIST Technical Advisor. Members of NCWM can participate
 3 in the PALS meetings by contacting Chair Guay. PALS work is being developed through monthly webinar meetings
 4 and at the NCWM meetings. PALS members are responsible for providing updates at their Regional Meetings. Chair
 5 Guay added PALS will be developing proposals and in addition providing guidance and recommendations on existing
 6 proposals as assigned by the NCWM L&R Committee. He stressed the importance of having key federal agencies
 7 (FDA, FTC, and USDA) participating.

8 **Item Development:**

9 NCWM 2023 Interim Meeting: Chairman Chris Guay provided the following written report on the activities of the
 10 Packaging and Labeling Subcommittee to the Laws and Regulations Committee.

11 At the 2023 NCWM Interim Meeting, Chairman Guay conducted a detailed review of the status and next steps for the
 12 proposed e-commerce regulation on the L&R agenda. PALS confirmed the only further comments received by any
 13 member were minor edits suggested by NIST in mid-December. PALS reviewed the edits to determine which should
 14 be brought before the committee during open hearings and to be included in the proposal following the annual meeting
 15 and which could be made editorially with at the discretion of L&R. Based on all member input, PALS will recommend
 16 the proposal for Voting status at the L&R open hearing.

17 PALS has a video meeting scheduled with US Federal Trade Commission to provide FTC with and overview of the
 18 NCWM, PALS, and the e-commerce proposal.

19 PALS will focus its efforts after the 2023 Interim Meeting to continue outreach on the e-commerce proposal and to
 20 finalize an NCWM best practice document on the topic of quantity-related statements appearing on a package PDP.

21 NCWM 2023 Annual Meeting: Mr. Christopher Guay, PALS, Chairman informed the Committee that the PALS
 22 meeting focused on E-Commerce and the attendees were encouraged to stand and speak during open hearings.

23 **Regional Associations' Comments:**

24 WWMA 2022 Annual Meeting: The WWMA L&R Committee would like to thank the PALS for their report. The
 25 WWMA L&R Committee Recommend as a developing item on the NCWM Agenda

26 SWMA 2022 Annual Meeting: No comments were provided. The Committee recommended Developing Status.

27 CWMA 2023 Annual Meeting: No comments were provided. The Committee recommended Developing Status.

28 NEWMA 2022 Interim Meeting: No comments were provided. The Committee recommended Developing Status.

29 Additional letters, presentation and data may have been submitted for consideration with this item. Please refer to
 30 <https://www.ncwm.com/publication-15> to review these documents.

OTH-11.1

Regional recommendation to NCWM on item status:

- Recommend as a Voting Item on the NCWM agenda
- Recommend as an Information Item on the NCWM agenda
- Recommend as an Assigned Item on the NCWM agenda
(To be developed by an NCWM Task Group or Subcommittee)
- Recommend as a Developing Item on the NCWM agenda
(To be developed by source of the proposal)
- Recommend Withdrawal of the Item from the NCWM agenda
(In the case of new proposals, do not forward this item to NCWM)
- No recommendation from the region to NCWM
(If this is a new proposal, it will not be forwarded to the national committee by this region)

Comments and justification for the regional recommendation to NCWM: *(This will appear in NCWM reports)*

Chris Guay, PALS Chairperson provided an activity update and invited interested attendees to be active members of the committee. He reported PALS is working on an E-commerce document which should be available in January.

The committee recommends this remain developing.

1

2 **ITEM BLOCK 1 (B1) RENEWABLE DIESEL AND DIESEL**

3 **Source:**

4 CC Consulting, LLC

5 **Purpose:**

6 Further refine the changes related to biodiesel made at the 2022 annual meeting. This proposal also includes needed
7 updates related to renewable diesel.

8 **B1: MOS-23.1 A Sections 2.31. Biodiesel and biodiesel Blends that Contain Greater Than or**
9 **Equal to 21% by Volume Biodiesel. and 2.40. Diesel Fuel.**

10

11 **Item under Consideration:**

12 Amend Handbook 130, Uniform Regulation for the Method of Sale of Commodities as follows:

13 **2.31. Biodiesel and Biodiesel Blends that contain greater than or equal to 21 % by volume biodiesel.**

14 **2.31.1. Identification of Product.** – Biodiesel shall be identified by the term “Biodiesel” with the designation
15 “B100.” ~~Biodiesel~~-Blends **that contain greater than 20 % by volume biodiesel** shall be identified by the
16 term “Biodiesel Blend.”

17 **2.31.2. Labeling of Retail Dispensers.**

18 **2.31.2.1. Labeling of Grade Required.** – Biodiesel and biodiesel blends **that contain greater than 20**
19 **% by volume biodiesel** shall be identified in accordance with both EPA and FTC requirements.

20 ~~**2.31.2.2. Automotive Fuel Rating.**— Biodiesel and biodiesel blends shall be labeled with its~~
21 ~~**automotive fuel rating in accordance with 16 CFR 306.**~~

1 **2.31.2.3. Biodiesel Blends.** – When biodiesel blends greater than 20 % by volume are offered by sale,
2 each side of the dispenser where fuel can be delivered shall have a label conspicuously placed that states
3 “Consult Vehicle Manufacturer Fuel Recommendations.” The lettering of this legend shall not be less
4 than 6 mm (1/4 in) in height by 0.8 mm (1/32 in) stroke; block style letters and the color shall be in
5 definite contrast to the background color to which it is applied.

6 **2.31.3. Documentation for Dispenser Labeling Purposes.** – The retailer shall be provided, at the time of
7 delivery of the fuel, a declaration of the volume percent biodiesel on an invoice, bill of lading, shipping paper,
8 or other document. This documentation is for dispenser labeling purposes only; it is the responsibility of any
9 potential blender to determine the amount of biodiesel in the diesel fuel prior to blending.

10 ~~**2.31.4. Exemption.** – Biodiesel blends that contain less than or equal to 5 % biodiesel by volume are exempt
11 from the requirements of Sections 2.31.1. Identification of Product, 2.31.2. Labeling of Retail Dispensers,
12 and 2.31.3. Documentation for Dispenser Labeling Purposes when it is sold as diesel fuel.~~

13 (Added 2008) (Amended 2022, and 20XX)

14 **2.40. Diesel Fuel.** – Shall meet the following requirements, based on the biodiesel concentration of the fuel:

15 (a) Diesel fuel that contains less than or equal to 5 % by volume biodiesel shall meet the latest version of
16 ASTM D975, “Standard Specifications for Diesel Fuels” and shall be sold as diesel fuel.

17 (b) Diesel fuel that contains greater than or equal to 6 % by volume biodiesel and that contains less than or
18 equal to 20 % by volume shall meet the latest version of ASTM D7467, “Standard Specifications for Diesel
19 Fuel Oil, Biodiesel Blend (B6 to B20).”

20 (c) Only fuel additive registered with the U.S. EPA may be used to additize diesel fuel, and the final product
21 shall meet the latest version of ASTM D975 and/or ASTM D7467.

22 **2.40.1. Premium Diesel Fuel.** – All diesel fuels identified on retail dispensers as premium, super, supreme,
23 or premier must conform to the following minimum requirements.

24 (a) **Cetane Number.** – A minimum cetane number of 47.0 as determined by the latest version of ASTM
25 D613, “Standard Test Method for Cetane Number of Diesel Fuel Oil.”

26 **NOTE:** ASTM D613, “Standard Test Method for Cetane Number of Diesel Fuel Oil” is the referee
27 method; however, the following methods can be used to determine cetane number: the latest version of
28 ASTM D6890, “Standard Test Method for Determination of Ignition Delay and Derived Cetane
29 Number” (DCN) of Diesel Fuel Oils by Combustion in a Constant Volume Chamber”; and ASTM
30 D7668, “Standard Test Method for Determination of Derived Cetane Number (DCN) of Diesel Fuel
31 Oils–Ignition Delay and Combustion Delay Using a Constant Volume Combustion Chamber Method.”

32 (b) **Low Temperature Operability.** – A cold flow performance measurement which meets the latest
33 version of ASTM D975, “Standard Specification for Diesel Fuel,” tenth percentile minimum ambient air
34 temperature charts and maps by the latest version of either ASTM D2500, “Standard Test Method for
35 Cloud Point of Petroleum Products and Liquid Fuels” or ASTM Standard D4539, “Standard Test Method
36 for Filterability of Diesel Fuels by Low-Temperature Flow Test (LTFT).” The latest version of ASTM
37 D6371, “Standard Test Method for Cold Filter Plugging Point of Diesel and Heating Fuels” may be used
38 when the test results are a maximum of 6 °C below the Cloud Point. Low temperature operability is only
39 applicable October 1 to March 31 of each year.

40 (c) **Lubricity.** – A maximum wear scar diameter of 460 micrometers as determined by the latest version
41 ASTM D6079, “Standard Test Method for Evaluating Lubricity of Diesel Fuels by the High-Frequency
42 Reciprocating Rig (HFRR).”

1 **NOTE:** The latest version of ASTM D6079, “Standard Test Method for Evaluating Lubricity of Diesel
2 Fuels by the High-Frequency Reciprocating Rig (HFRR)” is the referee method; however, the latest
3 version of ASTM D7688, “Standard Test Method for Evaluating Lubricity of Diesel Fuels by the High-
4 Frequency Reciprocating Rig (HFRR) by Visual Observation” can be used.

5 (d) **Corrosion.** – A minimum rating of B+ as determined by the most recent version of NACE TM0172,
6 “Determining Corrosive Properties of Cargoes in Petroleum Product Pipelines.”

7 **NOTE:** The latest recent version of NACE TM0172 “Determining Corrosive Properties of Cargoes in
8 Petroleum Product Pipelines” is the referee method. The latest version of ASTM D7548 “Standard Test
9 Method for Determination of Accelerated Iron Corrosion in Petroleum Products” can be used.

10 (e) **Filter Blocking Tendency (FBT)** – A maximum of 2.2 by the latest version of ASTM D2068,
11 “Standard Test Method for Determining Filter Blocking Tendency”, following procedure B.

12 (f) **Injector Deposit Control.** – Maximum power loss in keep-clean mode of 2 % by the latest version
13 of Coordinating European Council, CEC F-98-08, “Direct Injection, Common Rail Diesel Engine Nozzle
14 Coking Test.”

15 **2.40.2. Use of Other Diesel Terminology.** – For any terms other than premium, super, supreme, or premier
16 included in the diesel fuel product or grade name and/or advertisements and claims displayed on dispensers,
17 pump toppers, pole signs and bollard signs which imply improved performance, the product must have a
18 clearly-defined fuel property with a substantiated functional benefit. Such property must be measurable
19 utilizing industry accepted test methodologies developed by recognized standards organizations such as
20 ASTM, SAE, and CEC to allow verification of the improved performance.

21 **2.40.3. Labeling requirements – Diesel fuel containing more than 5 % by volume of biodiesel or more**
22 **than 5 % by volume of renewable diesel shall be identified in accordance with both EPA and FTC**
23 **requirements.**

24 (Added 2021) **(amended 20XX)**

25 **B1: FLR-23.1 A Sections 1.9. Biodiesel Blend., 1.27. Fuel Oil., 1.XX. Renewable Diesel., 3.3.2.**
26 **Automotive Fuel Rating., 3.15. Biodiesel and Biodiesel Blends Containing**
27 **Greater than 20% by Volume Biodiesel.**

28 **Item Under Consideration:**

29 Amend the Uniform Fuels and Automotive Lubricants Regulation as follows:

30 **1.8. Biodiesel.** – A fuel comprised of at least 99 % by volume mono-alkyl esters of long chain fatty acids derived
31 from vegetable oils or animal fats, designated B100 or B99.
32 (Amended 2018)

33 **1.9. Biodiesel Blend.** – A fuel comprised of a blend of biodiesel with hydrocarbon diesel fuel **and containing**
34 **greater than 20 % by volume biodiesel.**
35 (Amended 2018, **and 20XX**)

36 **1.15. Diesel Fuel.** – A refined hydrocarbon suitable for use as a fuel in a compression-ignition (diesel) internal
37 combustion engine that may contain a combination of biodiesel, renewable diesel, and fuel additives.
38 (Amended 2018)

1 **1.27. Fuel Oil.** – Refined oil middle distillates, heavy distillates, or residues of refining, or blends of these,
2 suitable for use as a fuel for heating or power generation. **The fuel may be refined from petroleum or**
3 **biomass and may contain biodiesel and fuel additives.**

4 **1.56. Wholesale Purchaser Consumer.** – Any person who is an ultimate consumer of gasoline, fuel methanol,
5 ethanol flex fuel, diesel fuel, biodiesel, biodiesel blends, fuel oil, kerosene, aviation turbine fuels, natural gas,
6 compressed natural gas, or liquefied petroleum gas and who purchases or obtains the product from a supplier
7 and receives delivery of that product into a storage tank.
8 (Added 1998) (Amended 1999 and 2014)

9 **1.XX Renewable Diesel.** – **A refined middle distillate hydrocarbon produced from biomass and suitable**
10 **for use as a fuel in a compression-ignition (diesel) internal combustion engine.**

11 **Section 2. Standard Specifications**

12 **2.2. Diesel Fuel.** – Shall meet the following requirements, based on the biodiesel concentration of the fuel:

13 (a) Diesel fuel that contains less than or equal to 5 % by volume biodiesel shall meet the latest version of
14 ASTM D975, “Standard Specifications for Diesel Fuels” and shall be sold as diesel fuel.

15 (b) Diesel fuel that contains greater than or equal to 6 % by volume biodiesel and that contains less than or
16 equal to 20 % by volume shall meet the latest version of ASTM D7467, “Standard Specifications for Diesel
17 Fuel Oil, Biodiesel Blend (B6 to B20).”

18 (c) Only fuel additive registered with the U.S. EPA may be used to additize diesel fuel, and the final product
19 shall meet the latest version of ASTM D975 and/or ASTM D7467.
20 (Amended 2003 and 2018)

21 **2.2.1. Premium Diesel Fuel.** – All diesel fuels identified on retail dispensers as premium, super, supreme,
22 or premier must conform to the following minimum requirements:

23 (a) **Cetane Number.** – A minimum cetane number of 47.0 as determined by the latest version of ASTM
24 D613, “Standard Test Method for Cetane Number of Diesel Fuel Oil.”

25 **NOTE:** ASTM D613, “Standard Test Method for Cetane Number of Diesel Fuel Oil” is the referee
26 method; however, the following methods can be used to determine cetane number: the latest version of
27 ASTM D6890, “Standard Test Method for Determination of Ignition Delay and Derived Cetane
28 Number” (DCN) of Diesel Fuel Oils by Combustion in a Constant Volume Chamber”; and ASTM
29 D7668, “Standard Test Method for Determination of Derived Cetane Number (DCN) of Diesel Fuel
30 Oils—Ignition Delay and Combustion Delay Using a Constant Volume Combustion Chamber Method.”
31 (Note added 2019)

32 (b) **Low Temperature Operability.** – A cold flow performance measurement which meets the latest
33 version of ASTM D975, “Standard Specification for Diesel Fuel,” tenth percentile minimum ambient air
34 temperature charts and maps by the latest version of either ASTM D2500, “Standard Test Method for
35 Cloud Point of Petroleum Products and Liquid Fuels” or ASTM D4539, “Standard Test Method for
36 Filterability of Diesel Fuels by Low Temperature Flow Test, (LTFT).” The latest version of ASTM
37 D6371, “Standard Test Method for Cold Filter Plugging Point of Diesel and Heating Fuels” may be used
38 when the test results are a maximum of 6 °C below the Cloud Point. Low temperature operability is only
39 applicable October 1 to March 31 of each year.

1 (c) **Lubricity.** – A maximum wear scar diameter of 460 micrometers as determined by the latest version
2 ASTM D6079, “Standard Test Method for Evaluating Lubricity of Diesel Fuels by the High-Frequency
3 Reciprocating Rig (HFRR).”

4 **NOTE:** The latest version of ASTM D6079, “Standard Test Method for Evaluating Lubricity of Diesel
5 Fuels by the High-Frequency Reciprocating Rig (HFRR)” is the referee method; however, the latest
6 version of ASTM D7688, “Standard Test Method for Evaluating Lubricity of Diesel Fuels by the High-
7 Frequency Reciprocating Rig (HFRR) by Visual Observation” can be used.
8 (Note added 2019)

9 (d) **Corrosion.** – A minimum rating of B+ as determined by the latest version of NACE TM0172,
10 “Determining Corrosive Properties of Cargoes in Petroleum Product Pipelines.”

11 **NOTE:** The latest version of NACE TM0172 “Determining Corrosive Properties of Cargoes in
12 Petroleum Product Pipelines” is the referee method. The latest version of ASTM D7548 “Standard Test
13 Method for Determination of Accelerated Iron Corrosion in Petroleum Products” can be used.
14 (Added 2019)

15 (e) **Filter Blocking Tendency (FBT).** – A maximum of 2.2 by the latest version of ASTM D2068,
16 “Standard Test Method for Determining Filter Blocking Tendency”, following procedure B.
17 (Added 2019)

18 (f) **Injector Deposit Control.** – Maximum power loss in keep-clean mode of 2 % by the latest version
19 of Coordinating European Council, CEC F-98-08, “Direct Injection, Common Rail Diesel Engine Nozzle
20 Coking Test.”
21 (Added 2019)

22 **2.2.2. Use of Other Diesel Terminology.** – For any terms other than premium, super, supreme, or premier
23 included in the diesel fuel product or grade name and/or advertisements and claims displayed on dispensers,
24 pump toppers, pole signs and bollard signs which imply improved performance, the product must have a
25 clearly-defined fuel property with a substantiated functional benefit. Such property must be measurable
26 utilizing industry accepted test methodologies developed by recognized standards organizations such as
27 ASTM, SAE, and CEC to allow verification of the improved performance.
28 (Added 2019)
29 (Amended 2003 and 2019)

30 **2.5. Fuel Oils.** – Shall meet the latest version of ASTM D396, “Standard Specification for Fuel Oils.”

31 **2.6. Kerosene (Kerosine).** – Shall meet the latest version of ASTM D3699, “Standard Specification for
32 Kerosine.”

33 **2.17. Biodiesel Blendstock.** – Biodiesel intended for blending with diesel fuel shall meet the latest version of
34 ASTM D6751, “Standard Specification for Biodiesel Fuel Blend Stock (B100) for Middle Distillate Fuels.” Any
35 blend stock less than 99 % by volume biodiesel (no more than 1 % by volume diesel fuel). Any blend stock less
36 than 99 % by volume shall not be used as a commercial blend stock for biodiesel blends without the permission
37 of the Director.
38 (Added 2004) (Amended 2018)

39 **Section 3. Classification and Labeling for Sale.**

40 **3.1. General Considerations.**

1 **3.1.1. Documentation.** – When products regulated by this rule are sold, an invoice, bill of lading, shipping
 2 paper, or other documentation must accompany each delivery other than a retail sale. This document must
 3 identify the quantity, the name of the product, the particular grade of the product, the applicable automotive
 4 fuel rating, and oxygenate type and content (if applicable), the name and address of the seller and buyer, and
 5 the date and time of the sale. Documentation must be retained at the retail establishment for a period not less
 6 than one year.
 7 (Amended 2008)

8 **3.1.2. Retail Dispenser Labeling.** – All retail dispensing devices must identify conspicuously the type of
 9 product (exception: gasoline and gasoline-oxygenate blends), the particular grade of the product (exception:
 10 No. 2 Diesel), and the applicable automotive fuel rating.
 11 (Amended 2018)

12 **3.1.3. Grade Name.** – The sale of any product under any grade name that indicates to the purchaser that it is
 13 of a certain automotive fuel rating or ASTM grade shall not be permitted unless the automotive fuel rating
 14 or grade indicated in the grade name is consistent with the value and meets the requirements of Section 2,
 15 Standard Specifications.

16 **3.1.4. Nozzle Requirements for Automotive Gasoline, Gasoline-Oxygenate Blends, and Diesel Fuel
 17 Dispensers.** – Each retail dispensing device from which fuel products are sold shall be equipped with a nozzle
 18 spout having a diameter that conforms with the latest version of SAE J285, “Dispenser Nozzle Spouts for
 19 Liquid Fuel Intended for Use with Spark-Ignition and Compression Ignition Engines.”
 20 (Added 2018)
 21 (Amended 2018)

22 **3.3. Diesel Fuel.**

23 **3.3.1. Labeling of Grade Required.** – Diesel Fuel other than No 2-D shall be identified by grade.
 24 (Amended 2018)

25 **3.3.2. Automotive Fuel Rating.** – Diesel fuel containing 6 % to 20 % by volume biodiesel **and/or containing**
 26 **6 % or greater renewable diesel** shall be labeled with its automotive fuel rating in accordance with the FTC
 27 “Automotive Fuel Ratings, Certification and Posting Rule,” 16 CFR 306.
 28 (Added 2018)

29 **3.3.3. Delivery Documentation for Premium Diesel.** – Before or at the time of delivery of premium diesel
 30 fuel, the retailer or the wholesale purchaser-consumer shall be provided on an invoice, bill of lading, shipping
 31 paper, or other documentation a declaration of all performance properties that qualifies the fuel as premium
 32 diesel fuel as required in Section 2.2.1. Premium Diesel Fuel.
 33 (Added 1998) (Amended 1999)
 34 (Amended 1998, 1999, 2008, 2012, and 2018)

35 **3.6. Fuel Oils.**

36 **3.6.1. Labeling of Grade Required.** – Fuel Oil shall be identified by the grades contained in the latest
 37 version of ASTM D396, “Standard Specification for Fuel Oils.”
 38 (Amended 2018)

39 **3.6.2. Retail Fuel Oil.** – Dispensers shall display the following legend:

40 “Warning – Not Suitable for Use in Unvented Heaters Requiring No. 1-K Kerosene.”

1 The lettering of this legend shall not be less than 12.7 mm (1/2 in) in height by 1.5 mm (1/16 in) strokes
2 (width of type), block style letters, and the color of lettering shall be in definite contrast to the background
3 color to which it is applied.

4 (Added 2018)

5 (Amended 2008 and 2018)

6 **3.15. Biodiesel and Biodiesel Blends containing greater than 20 % by volume biodiesel.**

7 **3.15.1. Identification of Product.** – Biodiesel Blendstock shall be identified by the term “biodiesel” with
8 the designation “B100” or “B99.”

9 (Amended 2018)

10 **3.15.2. Labeling of Retail Dispensers.**

11 **3.15.2.1. Labeling of Grade Required.** – Biodiesel shall be identified by the grades No. 1-B S15, ~~or~~
12 No. 1-B S500, No. 2-B S15, or No. 2-B S500.

13 (Amended 2018)

14 **3.15.2.2. Automotive Fuel Rating.** – Fuels meeting the above requirements and/or including
15 greater than 5 % renewable diesel ~~Biodiesel and biodiesel blends diesel~~ shall be labeled with its
16 automotive fuel rating in accordance with the FTC Automotive Fuel Ratings, Certification and Posting
17 Rule, 16 CFR 306.

18 (Amended 2018)

19 **3.15.2.3. Biodiesel Blends.** – When biodiesel blends greater than 20 % by volume are offered by sale,
20 each side of the dispenser where fuel can be delivered shall have a label conspicuously placed that states
21 “Consult Vehicle Manufacturer Fuel Recommendations.” The lettering of this legend shall not be less
22 than 6 mm (1/4 in) in height by 0.8 mm (1/32 in) stroke; block style letters and the color shall be in
23 definite contrast to the background color to which it is applied.

24 **3.15.3. Documentation for Dispenser Labeling Purposes.** – The retailer shall be provided, at the time of
25 delivery of the fuel, a declaration of the volume percent biodiesel on an invoice, bill of lading, shipping paper,
26 or other document. This documentation is for dispenser labeling purposes only; it is the responsibility of any
27 potential blender to determine the amount of biodiesel in the diesel fuel prior to blending.

28 ~~**3.15.4. Exemption.** – Biodiesel blends that contain less than or equal to 5 % biodiesel by volume are~~
29 ~~exempted from the requirements of Sections 3.15.1. Identification of Product, 3.15.2. Labeling of Retail~~
30 ~~Dispensers, and 3.15.3. Documentation for Dispenser Labeling Purposes when it is sold as “diesel fuel”~~
31 ~~as required in Section 3.3. Diesel Fuel.~~

32 (Added 2005) (Amended 2008 and 2018, and 20XX)

33 **Section 4. Retail Storage Tanks and Dispenser Filters**

34 **4.1. Water in Gasoline-Alcohol Blends, Biodiesel Blends, Ethanol Flex Fuel, Aviation Gasoline, and**
35 **Aviation Turbine Fuel.** – No water phase greater than 6 mm (1/4 in) as determined by an appropriate detection
36 paste or other acceptable means, is allowed to accumulate in any tank utilized in the storage of gasoline-alcohol
37 blend, biodiesel, biodiesel blends, ethanol flex fuel, aviation gasoline, and aviation turbine fuel.

38 (Amended 2008, 2012, and 2014)

39 **4.2. Water in Gasoline, Diesel, Gasoline-Ether, and Other Fuels.** – Water shall not exceed 25 mm (1 in) in
40 depth when measured with water indicating paste or other acceptable means in any tank utilized in the storage of

1 diesel, gasoline, gasoline-ether blends, and kerosene sold at retail except as required in Section 4.1. Water in
2 Gasoline-Alcohol Blends, Biodiesel Blends, Ethanol Flex Fuel, Aviation Gasoline, and Aviation Turbine Fuel.
3 (Amended 2008, 2012, and 2014)

4 **4.3. Dispenser Filters.**

5 **4.3.1. Engine Fuel Dispensers.**

6 (a) All gasoline, gasoline-alcohol blends, gasoline-ether blends, ethanol flex fuel, and M85 methanol
7 dispensers shall have a 10 micron or smaller nominal pore-sized filter.

8 (b) All biodiesel, biodiesel blends, diesel, and kerosene dispensers shall have a 30 micron or smaller
9 nominal pore-sized filter.

10 (Amended 2014)

11 **Previous Action:**

12 2023: Assigned – Fuels and Lubricants Subcommittee

13 **Original Justification:**

14 The proposed changes provide additional clarity to changes made related to biodiesel approved at the 2022 annual
15 meeting. The proposal also includes important information related to renewable diesel. The submitter recognizes that
16 some may think no changes are needed.

17 **Comments in Favor:**

18 **Regulatory:**

19 • 2023 Interim: Ms. Vanessa Benchea, Vanessa Benchea, FALS Chair: FALS Agree with Mr. Corr and
20 believes these items are fully developed and ready for a vote.

21 • 2023 Interim: Mr. Kevin Schnepf, California stated that California does not allow this technology, but
22 he does support this item.

23 **Industry:**

24 • 2023 Interim: Mr. Chuck Corr, Chuck Corr Consulting representing Iowa Renewable Fuels Association
25 recommended that item to be assigned to FALS, and he will lead a focus group to further develop it.
26

27 • 2023 Interim: Mr. Randy Jennings representing Clean Fuels Alliance American supported Chuck Corr's
28 proposal.

29 **Advisory:**

30 • 2023 Annual: None
31

32 **Comments Against:**

33 **Regulatory:**

34 • 2023 Annual: None
35

1 **Industry:**

- 2 • 2023 Annual: None
3

4 **Advisory:**

- 5 • 2023 Annual: None
6

7 **Neutral Comments:**

8 **Regulatory:**

- 9 • 2023 Annual: None
10

11 **Industry:**

- 12 • 2023 Annual: Mr. Chuck Corr, (Corr Consulting) Informed the Committee that new information has
13 been submitted and is intended to replace the current item. He requested that the new information be
14 part of NCWM Publication 15 so the Regional Associations could review it and provide feedback.
15

16 **Advisory:**

- 17 • 2023 Annual: None
18

19 **Item Development:**

20 NCWM 2023 Interim Meeting: The Committee designated Assigned status to this block and assigned the items to the
21 FALS subcommittee.

22 For more information or to provide comment, please contact the FALS Chair:

23 Ms. Vanessa Benchea
24 Florida Department of Agriculture and Consumer Services/Division of Consumer Services
25 (813) 868-8263, Vanessa.Benchea@fdacs.gov

26 NCWM 2023 Annual Meeting: The Committee agreed to include Mr. Corr's new language in its Carry Over report
27 for consideration by the Regional Associations. It will also be published in NCWM Publication 15.

28 The new language follows the Regional Associations comments as they pertain to the previous version of the item.

29 **Regional Associations' Comments:**

30 WWMA 2022 Annual Meeting: Rebecca Richardson, Clean Fuels Alliance America, supports continued development
31 of this item.

32 Mr. Kevin Schnepf of CDFA/DMS proposed several changes:

33 2.31.1. There are no current ASTM fuel quality standards for biodiesel, diesel blends greater than 20%. This section
34 would imply that there is.

35 Deletion of 2.31.2.2 I do not see a need for this deletion.

36 Deletion of 2.31.4. Exemption. I do not see a need for this deletion. This section clarifies that biodiesel, diesel blends
37 less than 5 % as considered diesel fuel.

1 Addition of 2.40.3 Labeling requirements: The FTC is covered in 2.31.2.2. If that section is deleted, then this
2 requirement would be necessary.

3 B1: FLR-23.1

4 1.9. Biodiesel Blend. There are no current ASTM fuel quality standards for biodiesel, diesel blends greater than 20%.
5 This section would imply that there is.

6 1.27 Fuel Oil. This is consistent with ASTM D396

7 1.XX Renewable Diesel. This is a weak definition that needs to be worked on.

8 3.3.2. Automotive Fuel Rating. – This is consistent with 16CRF306

9 3.15. Biodiesel and Biodiesel Blends containing greater than 20% by volume biodiesel. This is attempting to establish
10 biodiesel blends greater than 20% by volume.

11 3.15.2.1. Labeling of Grade Required. This Fixes a miss B-2 S15 grade label.

12 3.15.2.2. Automotive Fuel Rating. This is the FTC requirement.

13 3.15.2.3. Biodiesel Blends. This section was not modified but I recommend that it be removed as there is no fuel
14 quality standard for greater than 20% biodiesel, diesel blends.

15 3.15.4. Exemption. – This is consistent with 16CFR306

16 Based on testimony heard regarding this item not being fully developed, the WWMA L&R Committee recommends
17 this item be assigned Developing status.

18 SWMA 2022 Annual Meeting: Mr. Randy Jennings (Clean Fuels) commented that he is generally in support of the
19 items submitted and would like to see it go forward in some fashion. Speaking on his own behalf, he would like to
20 suggest an amendment to the definition for diesel fuel to align with the recently updated ASTM D975.

21 Mr. Joe Sorena (Chevron) recommends the item remain in development and L&R consider alternate wording proposed
22 concerning the concept of redefining the bio diesel blend containing greater than 20 %, as it is inconsistent with D7467
23 and will contribute to customer confusion.

24 Dr. Matthew Curran (Florida) commented he spoke with Chuck Corr regarding this item. Conceptually, approves this
25 section. Inconsistencies were described found in the titles of MOS-23.1 and FLR-23.1 and a recommendation for
26 clearer titles was made. He recommends in 2.31.2.1 verbiage is added to the specific EPA and FTC requirements.

27 Mr. Randy Jennings (Clean Fuels) suggested forming a focus group within FALS with Chuck Corr to lead and move
28 this item forward.

29 The Committee corrected the title as follows:

30 **B1: MOS-23.1 D Sections 2.231. Biodiesel and biodiesel Blends that Contain Greater Than or Equal to**
31 **21% by Volume Biodiesel. and 2.40. Diesel Fuel.**

32 The Committee agrees that this item needs more development and recommends this as a Developing Item on the
33 NCWM Agenda.

34 CWMA 2023 Annual Meeting: The CWMA recommended as an Assigned Item on the NCWM agenda.

1 Mr. Chuck Corr, Iowa Renewable Fuels Association, commented that the item is assigned to FALS which has formed
2 a focus group that will make a presentation in July at the FALS meeting.

3 NEWMA 2023 Annual Meeting: The NEWM recommended as an Assigned Item on the NCWM agenda.

4 Ms. Rebecca Richardson, Clean Fuels Alliance America offered an update on behalf of FALS stating that Chuck Corr,
5 Chuck Corr Consulting, will have an update ready for the NCWM annual meeting in July.

6 Additional letters, presentation and data may have been submitted for consideration with this item. Please refer to
7 <https://www.ncwm.com/publication-15> to review these documents.

8 **New Proposed Language Submitted:**

9 **B1:MOS-23.1**

10 **B. Uniform Regulation for the Method of Sale of Commodities**

11 **~~2.31. Biodiesel and Biodiesel Blends.~~**

12 ~~2.31.1. Identification of Product.— Biodiesel shall be identified by the term “Biodiesel” with the~~
13 ~~designation “B100.” Biodiesel Blends shall be identified by the term “Biodiesel Blend.”~~

14 ~~2.31.2. Labeling of Retail Dispensers.~~

15 ~~2.31.2.1. Labeling of Grade Required.— Biodiesel and biodiesel blends shall be identified in~~
16 ~~accordance with both EPA and FTC requirements.~~

17 ~~2.31.2.2. Automotive Fuel Rating.— Biodiesel and biodiesel blends shall be labeled with its automotive~~
18 ~~fuel rating in accordance with 16 CFR 306.~~

19 ~~2.31.2.3. Biodiesel Blends.— When biodiesel blends greater than 20 % by volume are offered by sale,~~
20 ~~each side of the dispenser where fuel can be delivered shall have a label conspicuously placed that~~
21 ~~states “Consult Vehicle Manufacturer Fuel Recommendations.” The lettering of this legend shall not~~
22 ~~be less than 6 mm (¹/₄ in) in height by 0.8 mm (¹/₃₂ in) stroke; block style letters and the color shall be~~
23 ~~in definite contrast to the background color to which it is applied.~~

24 ~~2.31.3. Documentation for Dispenser Labeling Purposes.— The retailer shall be provided, at the time of~~
25 ~~delivery of the fuel, a declaration of the volume percent biodiesel on an invoice, bill of lading, shipping~~
26 ~~paper, or other document. This documentation is for dispenser labeling purposes only; it is the~~
27 ~~responsibility of any potential blender to determine the amount of biodiesel in the diesel fuel prior to~~
28 ~~blending.~~

29 ~~2.31.4. Exemption.— Biodiesel blends that contain less than or equal to 5 % biodiesel by volume are~~
30 ~~exempt from the requirements of Sections 2.31.1. Identification of Product, 2.31.2. Labeling of Retail~~
31 ~~Dispensers, and 2.31.3. Documentation for Dispenser Labeling Purposes when it is sold as diesel fuel.~~

32 ~~(Added 2008) (Amended 2022)~~

33 **2.40. Diesel Fuel.** – Shall meet the following requirements, based on the biodiesel concentration of the fuel:

34 (a) Diesel fuel that contains less than or equal to 5 % by volume biodiesel shall meet the latest version of ASTM
35 D975, “Standard Specifications for Diesel Fuels” and shall be sold as diesel fuel.

- 1 (b) Diesel fuel that contains **biodiesel in concentrations** greater than or equal to 6 % by volume ~~biodiesel~~ and
2 ~~that contains~~ less than or equal to 20 % by volume shall meet the latest version of ASTM D7467, “Standard
3 Specifications for Diesel Fuel Oil, Biodiesel Blend (B6 to B20).”
- 4 (c) Diesel fuel that contains greater than or equal to 21 % by volume biodiesel shall be a blend of fuel from
5 (a) or (b) and biodiesel meeting the latest version of ASTM D6751, “Standard Specification for
6 Biodiesel Fuel Blend Stock (B100) for Middle Distillate Fuels.”
- 7 (d) Only fuel additive registered with the U.S. EPA may be used to additize diesel fuel, ~~and the final product~~
8 ~~shall meet the latest version of ASTM D975 and/or ASTM D7467.~~

9 **2.40.1. Labeling of Retail Dispensers.**

10 **2.40.1.1. FTC Automotive Fuel Rating.** – Diesel fuel shall be labeled with its automotive fuel rating
11 in accordance with Automotive Fuel Ratings, Certification and Posting Rule 16 C.F.R. 306. Diesel fuel
12 that contains less than or equal to 5 % by volume biodiesel and/or less than or equal to 5 % by volume
13 biomass-based diesel does not require an FTC label.

14 **2.40.1.2. Biodiesel Concentrations Greater than 21 % -** When diesel fuel that contains biodiesel
15 concentrations greater than or equal to 21 % by volume is offered by sale, each side of the dispenser
16 where fuel can be delivered shall have a label conspicuously placed that states “Consult Vehicle
17 Manufacturer Fuel Recommendations.” The lettering of this legend shall not be less than 6 mm (¹/₄ in)
18 in height by 0.8 mm (¹/₃₂ in) stroke; block style letters and the color shall be in definite contrast to the
19 background color to which it is applied.

20 **2.40.1.3. Documentation for Dispenser Labeling Purposes.** –The retailer shall be provided, at the time
21 of delivery of the fuel, a declaration of the volume percent biodiesel and or volume percent of renewable
22 diesel on an invoice, bill of lading, shipping paper, or other document. This documentation is for
23 dispenser labeling purposes only; it is the responsibility of any potential blender to determine the
24 amount of biodiesel in the diesel fuel prior to blending.

25 **2.40.1.4. Delivery Documentation for Premium Diesel or Other Diesel Terminology Claims.** – Before
26 or at the time of delivery of the diesel fuel, the retailer or the wholesale purchaser-consumer shall be
27 provided on an invoice, bill of lading, shipping paper, or other documentation a declaration of all
28 performance properties that qualifies the fuel as premium diesel fuel as required in Section 2.40.2.
29 Premium Diesel Fuel and 2.40.3. Use of Other Diesel Terminology.

30 **(Added 20XX)**

31 **2.40.2. 2.40.1. Premium Diesel Fuel.** – All diesel fuels identified on retail dispensers as premium, super,
32 supreme, or premier must conform to the following minimum requirements.

- 33 (a) **Cetane Number.** – A minimum cetane number of 47.0 as determined by the latest version of ASTM
34 D613, “Standard Test Method for Cetane Number of Diesel Fuel Oil.”

35 *NOTE:* ASTM D613, “Standard Test Method for Cetane Number of Diesel Fuel Oil” is the referee
36 method; however, the following methods can be used to determine cetane number: the latest version of
37 ASTM D6890, “Standard Test Method for Determination of Ignition Delay and Derived Cetane
38 Number” (DCN) of Diesel Fuel Oils by Combustion in a Constant Volume Chamber”; and ASTM
39 D7668, “Standard Test Method for Determination of Derived Cetane Number (DCN) of Diesel Fuel
40 Oils–Ignition Delay and Combustion Delay Using a Constant Volume Combustion Chamber Method.”

- 41 (b) **Low Temperature Operability.** – A cold flow performance measurement which meets the latest version
42 of ASTM D975, “Standard Specification for Diesel Fuel,” tenth percentile minimum ambient air
43 temperature charts and maps by the latest version of either ASTM D2500, “Standard Test Method for

1 Cloud Point of Petroleum Products and Liquid Fuels” or ASTM Standard D4539, “Standard Test Method
2 for Filterability of Diesel Fuels by Low-Temperature Flow Test (LTFT).” The latest version of ASTM
3 D6371, “Standard Test Method for Cold Filter Plugging Point of Diesel and Heating Fuels” may be used
4 when the test results are a maximum of 6 °C below the Cloud Point. Low temperature operability is
5 only applicable October 1 to March 31 of each year.

- 6 (c) **Lubricity.** – A maximum wear scar diameter of 460 micrometers as determined by the latest version
7 ASTM D6079, “Standard Test Method for Evaluating Lubricity of Diesel Fuels by the High-Frequency
8 Reciprocating Rig (HFRR).”

9 **NOTE:** The latest version of ASTM D6079, “Standard Test Method for Evaluating Lubricity of Diesel
10 Fuels by the High-Frequency Reciprocating Rig (HFRR)” is the referee method; however, the latest
11 version of ASTM D7688, “Standard Test Method for Evaluating Lubricity of Diesel Fuels by the High-
12 Frequency Reciprocating Rig (HFRR) by Visual Observation” can be used.

- 13 (d) **Corrosion.** – A minimum rating of B+ as determined by the most recent version of NACE TM0172,
14 “Determining Corrosive Properties of Cargoes in Petroleum Product Pipelines.”

15 **NOTE:** The latest recent version of NACE TM0172 “Determining Corrosive Properties of Cargoes in
16 Petroleum Product Pipelines” is the referee method. The latest version of ASTM D7548 “Standard Test
17 Method for Determination of Accelerated Iron Corrosion in Petroleum Products” can be used.

- 18 (e) **Filter Blocking Tendency (FBT)** – A maximum of 2.2 by the latest version of ASTM D2068, “Standard
19 Test Method for Determining Filter Blocking Tendency”, following procedure B.

- 20 (f) **Injector Deposit Control.** – Maximum power loss in a keep-clean mode of 2 % by the latest version of
21 Coordinating European Council, CEC F-98-08, “Direct Injection, Common Rail Diesel Engine Nozzle
22 Coking Test.”

23 **2.40.3. 2.40.2. Use of Other Diesel Terminology** – For any terms other than premium, super, supreme, or
24 premier included in the diesel fuel product or grade name and/or advertisements and claims displayed on
25 dispensers, pump toppers, pole signs, and bollard signs which imply improved performance, the product must
26 have a clearly-defined fuel property with a substantiated functional benefit. Such property must be measurable
27 utilizing industry-accepted test methodologies developed by recognized standards organizations such as ASTM,
28 SAE, and CEC to allow verification of the improved performance.

29 (Added 2021) (**Amended 20XX**)

30 B1:FLR-23.1

31 F. Uniform Fuels and Automotive Lubricants Regulation

32 Section 1. Definitions

33 **1.8. Biodiesel.** – A fuel comprised of at least 99 % by volume mono-alkyl esters of long chain fatty acids derived
34 from vegetable oils or animal fats, designated B100 or B99.

35 (Amended 2018)

36 **1.9. Biodiesel Blend** – A fuel comprised of a homogeneous mixture of hydrocarbon oils and mono-alkyl esters
37 of long-chain fatty acids. a blend of biodiesel with hydrocarbon diesel fuel.

38 (Amended 2018)

1 **1.11. Cetane Number.** – A numerical measure of the ignition performance of a diesel fuel obtained by comparing it
2 to reference fuels in a standardized engine test.

3 **1.15. Diesel Fuel** – ~~A refined hydrocarbon suitable for use as a fuel in a compression-ignition (diesel) internal~~
4 ~~combustion engine that may contain a combination of biodiesel, renewable diesel, and fuel additives.~~ A liquid
5 fuel specifically designed for injection into a compression-ignition engine to provide energy, commonly
6 composed of hydrocarbons refined from petroleum or biomass and the fuel may contain biodiesel and fuel
7 additives.

8 (Amended 2018 and 20XX)

9 **1.XX. Fuel Oil.** – A liquid fuel designed for use in open flame applications to provide energy, commonly
10 composed of hydrocarbons refined from petroleum or biomass and the fuel may contain biodiesel and fuel
11 additives. The fuel may also be used in select compression-ignition engines.

12 **1.XX. Biomass-based Diesel.** - A hydrocarbon diesel fuel refined from biomass.

13 **Section 2. Standard Specifications**

14 **2.2. Diesel Fuel.** – Shall meet the following requirements, based on the biodiesel concentration of the fuel:

15 (a) Diesel fuel that contains less than or equal to 5 % by volume biodiesel shall meet the latest version of
16 ASTM D975, “Standard Specifications for Diesel Fuels” and shall be sold as diesel fuel.

17 (b) Diesel fuel that contains biodiesel in concentrations greater than or equal to 6 % by volume ~~biodiesel~~
18 ~~that contains~~ less than or equal to 20 % by volume shall meet the latest version of ASTM D7467,
19 “Standard Specifications for Diesel Fuel Oil, Biodiesel Blend (B6 to B20).”

20 (c) Diesel fuel that contains greater than or equal to 21 % by volume biodiesel shall be a blend of fuel
21 from (a) or (b) and biodiesel meeting the latest version of ASTM D6751, “Standard Specification
22 for Biodiesel Fuel Blend Stock (B100) for Middle Distillate Fuels.”

23 (d) Only fuel additive registered with the U.S. EPA may be used to additize diesel fuel, ~~and the final~~
24 ~~product shall meet the latest version of ASTM D975 and/or ASTM D7467.~~

25 (Amended 2003, and 2018, and 20XX)

26 **2.2.1. Premium Diesel Fuel.** – All diesel fuels identified on retail dispensers as premium, super, supreme, or
27 premier must conform to the following minimum requirements:

28 (a) **Cetane Number.** – A minimum cetane number of 47.0 as determined by the latest version of ASTM
29 D613, “Standard Test Method for Cetane Number of Diesel Fuel Oil.”

30 *NOTE:* ASTM D613, “Standard Test Method for Cetane Number of Diesel Fuel Oil” is the referee
31 method; however, the following methods can be used to determine cetane number: the latest version of
32 ASTM D6890, “Standard Test Method for Determination of Ignition Delay and Derived Cetane
33 Number” (DCN) of Diesel Fuel Oils by Combustion in a Constant Volume Chamber”; and ASTM
34 D7668, “Standard Test Method for Determination of Derived Cetane Number (DCN) of Diesel Fuel
35 Oils–Ignition Delay and Combustion Delay Using a Constant Volume Combustion Chamber Method.”

36 (Note Added 2019)

37 (b) **Low Temperature Operability.** – A cold flow performance measurement which meets the latest version
38 of ASTM D975, “Standard Specification for Diesel Fuel,” tenth percentile minimum ambient air
39 temperature charts and maps by the latest version of either ASTM D2500, “Standard Test Method for

1 Cloud Point of Petroleum Products and Liquid Fuels” or ASTM D4539, “Standard Test Method for
2 Filterability of Diesel Fuels by Low Temperature Flow Test, (LTFT).” The latest version of ASTM
3 D6371, “Standard Test Method for Cold Filter Plugging Point of Diesel and Heating Fuels” may be used
4 when the test results are a maximum of 6 °C below the Cloud Point. Low temperature operability is
5 only applicable October 1 to March 31 of each year.

6 (c) **Lubricity.** – A maximum wear scar diameter of 460 micrometers as determined by the latest version
7 ASTM D6079, “Standard Test Method for Evaluating Lubricity of Diesel Fuels by the High-Frequency
8 Reciprocating Rig (HFRR).”

9 *NOTE:* The latest version of ASTM D6079, “Standard Test Method for Evaluating Lubricity of Diesel
10 Fuels by the High-Frequency Reciprocating Rig (HFRR)” is the referee method; however, the latest
11 version of ASTM D7688, “Standard Test Method for Evaluating Lubricity of Diesel Fuels by the High-
12 Frequency Reciprocating Rig (HFRR) by Visual Observation” can be used.

13 (Note Added 2019)

14 (d) **Corrosion.** – A minimum rating of B+ as determined by the latest version of NACE TM0172,
15 “Determining Corrosive Properties of Cargoes in Petroleum Product Pipelines.”

16 *NOTE:* The latest version of NACE TM0172 “Determining Corrosive Properties of Cargoes in
17 Petroleum Product Pipelines” is the referee method. The latest version of ASTM D7548 “Standard Test
18 Method for Determination of Accelerated Iron Corrosion in Petroleum Products” can be used.

19 (Added 2019)

20 (e) **Filter Blocking Tendency (FBT).** – A maximum of 2.2 by the latest version of ASTM D2068,
21 “Standard Test Method for Determining Filter Blocking Tendency”, following procedure B.

22 (Added 2019)

23 (f) **Injector Deposit Control.** – Maximum power loss in a keep-clean mode of 2 % by the latest version of
24 Coordinating European Council, CEC F-98-08, “Direct Injection, Common Rail Diesel Engine Nozzle
25 Coking Test.”

26 (Added 2019)

27 **2.2.2. Use of Other Diesel Terminology.** – For any terms other than premium, super, supreme, or premier
28 included in the diesel fuel product or grade name and/or advertisements and claims displayed on dispensers, pump
29 toppers, pole signs, and bollard signs which imply improved performance, the product must have a clearly-defined
30 fuel property with a substantiated functional benefit. Such property must be measurable utilizing industry
31 accepted test methodologies developed by recognized standards organizations such as ASTM, SAE, and CEC to
32 allow verification of the improved performance.

33 (Added 2019)

34 (Amended 2003 and 2019)

35 **2.5. Fuel Oils.** – Shall meet the latest version of ASTM D396, “Standard Specification for Fuel Oils.”

36 **2.17. Biodiesel Blendstock** – Biodiesel intended for blending with diesel fuel shall meet the latest version of
37 ASTM D6751, “Standard Specification for Biodiesel Fuel Blend Stock (B100) for Middle Distillate Fuels.” Any
38 blend stock less than 99 % by volume biodiesel (no more than 1 % by volume diesel fuel). Any blend stock less than

1 99 % by volume shall not be used as a commercial blend stock for biodiesel blends without the permission of the
 2 Director.
 3 (Added 2004) (Amended 2018)

4 **Section 3. Classification and Labeling for Sale**

5 **3.1. General Considerations.**

6 **3.1.1. Documentation.** –When products regulated by this rule are sold, an invoice, bill of lading, shipping
 7 paper, or other documentation must accompany each delivery other than a retail sale. This document must identify
 8 the quantity, the name of the product, the particular grade of the product, the applicable automotive fuel rating,
 9 and oxygenate type and content (if applicable), the name and address of the seller and buyer, and the date and
 10 time of the sale. Documentation must be retained at the retail establishment for a period not less than one year.
 11 (Amended 2008)

12 **3.1.2. Retail Dispenser Labeling.** –All retail dispensing devices must identify conspicuously the type of
 13 product (exception: gasoline and gasoline-oxygenate blends), the particular grade of the product (exception: No.
 14 2 Diesel), and the applicable automotive fuel rating.
 15 (Amended 2018)

16 **3.1.3. Grade Name.** – The sale of any product under any grade name that indicates to the purchaser that it is
 17 of a certain automotive fuel rating or ASTM grade shall not be permitted unless the automotive fuel rating or
 18 grade indicated in the grade name is consistent with the value and meets the requirements of Section 2, Standard
 19 Specifications.

20 **3.1.4. Nozzle Requirements for Automotive Gasoline, Gasoline-Oxygenate Blends, and Diesel Fuel**
 21 **Dispensers.** –Each retail dispensing device from which fuel products are sold shall be equipped with a nozzle
 22 spout having a diameter that conforms with the latest version of SAE J285, “Dispenser Nozzle Spouts for Liquid
 23 Fuel Intended for Use with Spark-Ignition and Compression Ignition Engines.”
 24 (Added 2018)
 25 (Amended 2018)

26 **3.3. Diesel Fuel.**

27 **3.3.1. Labeling of Retail Dispensers.**

28 **3.3.1.1. FTC Automotive Fuel Rating.** – **Diesel fuel shall be labeled with its automotive fuel rating in**
 29 **accordance with Automotive Fuel Ratings, Certification and Posting Rule 16 C.F.R. 306. Diesel fuel**
 30 **that contains less than or equal to 5 % by volume biodiesel and/or less than or equal to 5 % by volume**
 31 **biomass-based diesel does not require an FTC label.**

32 **3.3.1.2. Biodiesel Concentrations Greater than 21 % – When diesel fuel that contains biodiesel**
 33 **concentrations greater than or equal to 21 % by volume is offered by sale, each side of the dispenser**
 34 **where fuel can be delivered shall have a label conspicuously placed that states “Consult Vehicle**
 35 **Manufacturer Fuel Recommendations.” The lettering of this legend shall not be less than 6 mm (1/4 in)**

1 in height by 0.8 mm (¹/₃₂ in) stroke; block style letters and the color shall be in definite contrast to the
2 background color to which it is applied.

3 3.3.1.3. Labeling of Grade Required. – Diesel Fuel other than No 2-D shall be identified by grade.
4 (Added 20XX)

5 3.3.2. Documentation for Dispenser Labeling Purposes.

6 3.3.2.1. The retailer shall be provided, at the time of delivery of the fuel, a declaration of the volume
7 percent biodiesel and or volume percent of renewable diesel on an invoice, bill of lading, shipping
8 paper, or other document. This documentation is for dispenser labeling purposes only; it is the
9 responsibility of any potential blender to determine the amount of biodiesel in the diesel fuel prior to
10 blending.

11 ~~3.3.1. Labeling of Grade Required – Diesel Fuel other than No 2-D shall be identified by grade.~~
12 ~~(Amended 2018)~~

13 ~~3.3.2. Automotive Fuel Rating. – Diesel fuel containing 6 % to 20 % by volume biodiesel shall be~~
14 ~~labeled with its automotive fuel rating in accordance with the FTC “Automotive Fuel Ratings,~~
15 ~~Certification and Posting Rule,” 16 CFR 306.~~

16 ~~(Added 2018) (Amended 20XX)~~

17 3.3.2.2. ~~3.3.3.~~ Delivery Documentation for Premium Diesel or Other Diesel Terminology Claims. –
18 Before or at the time of delivery of the premium diesel fuel, the retailer or the wholesale purchaser-consumer
19 shall be provided on an invoice, bill of lading, shipping paper, or other documentation a declaration of all
20 performance properties that qualifies the fuel as premium diesel fuel as required in Section 2.2.1. Premium
21 Diesel Fuel and 2.2.2 Use of Other Diesel Terminology.

22 ~~(Added 1998) (Amended 1999 and 20XX)~~

23 ~~(Amended 1998, 1999, 2008, 2012, and 2018, and 20XX)~~

24 **3.6. Fuel Oils.**

25 **3.6.1. Labeling of Grade Required.** –Fuel Oil shall be identified by the grades contained in the latest version
26 of ASTM D396, “Standard Specification for Fuel Oils.”

27 (Amended 2018)

28 **3.6.2. Retail Fuel Oil.** –Dispensers shall display the following legend:

29 “Warning – Not Suitable for Use in Unvented Heaters Requiring No. 1-K Kerosene.”

30 The lettering of this legend shall not be less than 12.7 mm (¹/₂ in) in height by 1.5 mm (¹/₁₆ in) strokes (width of
31 type), block style letters, and the color of lettering shall be in definite contrast to the background color to which
32 it is applied.

33 (Added 2018)

34 (Amended 2008 and 2018)

35 ~~**3.15. Biodiesel and Biodiesel Blends**~~

36 ~~**3.15.1. Identification of Product.** –Biodiesel Blendstock shall be identified by the term “biodiesel” with~~
37 ~~the designation “B100” or “B99.”~~

38 ~~(Amended 2018)~~

1 **3.15.2. Labeling of Retail Dispensers.**

2 ~~3.15.2.1. Labeling of Grade Required. Biodiesel shall be identified by the grades No. 1-B S15 or~~
3 ~~No. 1-B S500, or No. 2-B S500.~~

4 ~~(Amended 2018)~~

5 ~~3.15.2.2. Automotive Fuel Rating. Biodiesel and biodiesel blends shall be labeled with its automotive~~
6 ~~fuel rating in accordance with the FTC Automotive Fuel Ratings, Certification and Posting Rule,~~
7 ~~16 CFR 306.~~

8 ~~(Amended 2018)~~

9 ~~3.15.2.3. Biodiesel Blends. When biodiesel blends greater than 20 % by volume are offered by sale,~~
10 ~~each side of the dispenser where fuel can be delivered shall have a label conspicuously placed that~~
11 ~~states “Consult Vehicle Manufacturer Fuel Recommendations.”~~

12 ~~The lettering of this legend shall not be less than 6 mm (1/4 in) in height by 0.8 mm (1/32 in) stroke; block~~
13 ~~style letters and the color shall be in definite contrast to the background color to which it is applied.~~

14 ~~3.15.3. Documentation for Dispenser Labeling Purposes. The retailer shall be provided, at the time of~~
15 ~~delivery of the fuel, a declaration of the volume percent biodiesel on an invoice, bill of lading, shipping~~
16 ~~paper, or other document. This documentation is for dispenser labeling purposes only; it is the~~
17 ~~responsibility of any potential blender to determine the amount of biodiesel in the diesel fuel prior to~~
18 ~~blending.~~

19 ~~3.15.4. Exemption. Biodiesel blends that contain less than or equal to 5 % biodiesel by volume are~~
20 ~~exempted from the requirements of Sections 3.15.1. Identification of Product, 3.15.2. Labeling of Retail~~
21 ~~Dispensers, and 3.15.3. Documentation for Dispenser Labeling Purposes when it is sold as “diesel fuel” as~~
22 ~~required in Section 3.3. Diesel Fuel.~~

23 ~~(Added 2005) (Amended 2008 and 2018)~~

24 Additional letters, presentation and data may have been submitted for consideration with this item. Please refer to
25 <https://www.ncwm.com/publication-15> to review these documents.

26 **ITEM BLOCK 2 (B2) REFERENCE ASTM STANDARDS D8080 AND D8487**

27 **B2: MOS-24.1 2.9. Liquefied Natural Gas (LNG) Vehicle Fuel., 2.10. Compressed Natural**
28 **Gas (CNG)., and 2.XX. Compressed Natural Gas (CNG) Blended with**
29 **Hydrogen**

30
31 **Source:**
32 AMT Consulting

33 **Purpose:**
34 Amend NIST HB 130 B. Uniform Regulation for the Method of Sale of Commodities: sections 2.9 and 2.10 by
35 replacing SAE J1616 and SAE J2699 with ASTM D8080 “Standard Specification for Compressed Natural Gas (CNG)
36 and Liquefied Natural Gas (LNG) Used as a Motor Vehicle Fuel.”
37

1 Amend NIST HB 130 B. Uniform Regulation for the Method of Sale of Commodities, Section 2 by adding a new
2 paragraph for ASTM D8487 “Standard Specification for Natural Gas, Hydrogen Blends for Use as a Motor Vehicle
3 Fuel.”.

4
5 Amend NIST HB 130 F. Uniform Fuels and Automotive Lubricants Regulation sections 3.10 and 3.11 by adding
6 labeling of grades to the method of sale for CNG and LNG.

7 **Item under Consideration:**

8 Amend the Uniform Regulation for the Method of Sale of Commodities as follows:

9 **2.9. Liquefied Natural Gas (LNG) Vehicle Fuel.** – Shall meet the latest version of ~~SAE J2699, “Liquefied~~
10 ~~Natural Gas (LNG) Vehicle Fuel.”~~ ASTM D8080 “Standard Specification for Compressed Natural Gas
11 (CNG) and Liquefied Natural Gas (LNG) Used as a Motor Vehicle Fuel.”

12 **2.10. Compressed Natural Gas (CNG).** – Shall meet the latest version of ~~SAE J1616,~~
13 ~~“Recommended Practice for Compressed Natural Gas Vehicle Fuel.”~~ ASTM D8080 “Standard
14 Specification for Compressed Natural Gas (CNG) and Liquefied Natural Gas (LNG) Used as a Motor
15 Vehicle Fuel.”

16 2.XX Compressed Natural Gas (CNG) blended with hydrogen. Shall meet the latest version of ASTM
17 D8487 “Standard Specification for Natural Gas, Hydrogen Blends for Use as a Motor Vehicle Fuel.”

18 **Previous Status:**

19 New in 2024

20 **B2: FLR-24.1 3.11.2.1.X. Identification of Grade. and 3.12.2.X. Identification of Grade.**

21 **Item under Consideration:**

22 Amend the Uniform Regulation for the Method of Sale of Commodities as follows:

23 **3.11.2.1.X. Identification of Grade.** – **Each retail dispenser of CNG shall be labeled with an identification**
24 **of the grade of the product.**

25 **3.12.2.X. Identification of Grade.** – **Each retail dispenser of LNG shall be labeled with an identification of**
26 **the grade of the product.**

27 **Previous Status:**

28 New in 2024

29 **Original Justification:**

30 ASTM Committee D03 on Gaseous Fuels has adopted two new fuel quality specifications for natural gas vehicles:

31 ASTM D8080 “Standard Specification for Compressed Natural Gas (CNG) and Liquefied Natural Gas (LNG)
32 Used as a Motor Vehicle Fuel”

33 ASTM D8487 “Standard Specification for Natural Gas, Hydrogen Blends for Use as a Motor Vehicle Fuel”.

34 These specifications are a replacement for both SAE J1616 (CNG) and SAE J2699 (LNG).

35 ASTM D8080 is intended for natural gas vehicle fuels that have no additional hydrogen blend in the fuel. The
36 specification establishes performance grades based on the fuel resistance to engine knock, energy content, and
37 sulfur levels.

1 ASTM D8487 is intended for natural gas vehicle fuels that have additional hydrogen blended in the fuel. The
2 specification covers natural gas fuels that have been blended with hydrogen and establishes performance grades
3 based on the fuel resistance to engine knock, energy content, and sulfur levels. This specification is to be used in
4 locations where hydrogen is being blended into the natural gas supply. This will become increasingly important
5 as the natural gas supply has hydrogen blended to meet the decarbonization efforts of the US.

6 Both these standards are applicable at the point of dispensing into the vehicle fuel tank.

7 This proposal will require dispensers to be labeled with the product grade. This will require the product
8 composition to be determined.

9 The submitter requested that the status be “Developing”.

10 **Comments in Favor:**

11 **Regulatory:**

- 12 •

13 **Industry:**

- 14 •

15 **Advisory:**

- 16 •

17 **Comments Against:**

18 **Regulatory:**

- 19 •

20 **Industry:**

- 21 •

22 **Advisory:**

- 23 •

24 **Neutral Comments:**

25 **Regulatory:**

- 26 •

27 **Industry:**

- 28 •

29 **Advisory:**

- 30 •

31 **Item Development:**

32 New Proposal

33 **Regional Associations’ Comments:**

34 New Proposal

- 1 Additional letters, presentation and data may have been submitted for consideration with this item. Please refer to
2 <https://www.ncwm.com/publication-15> to review these documents.

ITEM BLOCK 1

Regional recommendation to NCWM on item status:

- Recommend as a Voting Item on the NCWM agenda
- Recommend as an Information Item on the NCWM agenda
- Recommend as an Assigned Item on the NCWM agenda
(To be developed by an NCWM Task Group or Subcommittee)
- Recommend as a Developing Item on the NCWM agenda
(To be developed by source of the proposal)
- Recommend Withdrawal of the Item from the NCWM agenda
(In the case of new proposals, do not forward this item to NCWM)
- No recommendation from the region to NCWM
(If this is a new proposal, it will not be forwarded to the national committee by this region)

Comments and justification for the regional recommendation to NCWM: *(This will appear in NCWM reports)*

Chuck Corr, Iowa Renewable Fuels Association commented that this block was Assigned to FALS. The item has been updated, and the focus group will reconvene in November. He expects the final version by January 2024 and intends for the item to achieve Voting status. Mr. Corr further commented that this is found in Labeling of Retail Dispensers 2.40.1.3 L&R page 158, line 12, the word “renewable” should be replaced with “biomass-based”. Similarly, on Documentation for Dispenser Labeling Purposes 3.3.2.1 L&R page 162, line 32 the same correction should be made. This change is to keep the item consistent with Federal Trade Commission terminology.

The committee recommends this item remain assigned to FALS.

3

4

-
- 1
 - 2 Mr. Mike Harrington, Iowa | Committee Chair
 - 3 Mr. Sandy Wyss, Missouri | Member
 - 4 Mr. Tim White, Michigan | Member
 - 5 Ms. Brenda Geist, Kansas | Member
 - 6 Ms. Rebecca Richardson | AMC Representative
 - 7 Mr. Mike Harrington, Iowa | NCWM Representative

CWMA Laws and Regulations Committee